

***DCU 001***

***DCU 100***

***DCU 150***

***DCU 200***

***DCU 300***

***DCU 600***

---

## ***Display And Operating Unit***

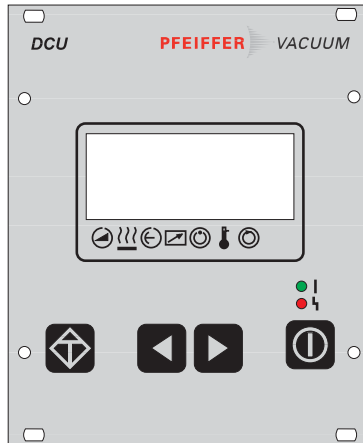

# Index

	Page
<b>1. Safety Instructions</b> .....	<b>3</b>
<b>2. Understanding The Control And Operating Unit DCU</b> .....	<b>4</b>
2.1. For Your Orientation .....	4
2.2. Product Description .....	4
Mechanical Design .....	4
Connection Options .....	5
Proper Use .....	5
Improper Use .....	5
2.3. Front Panel .....	5
2.4. Rear Panel .....	6
<b>3. Installation</b> .....	<b>7</b>
3.1. Preparations For Installation .....	7
3.2. Rack Fitting .....	7
3.3. Connecting Diagram .....	7
3.4. Making The Connections .....	8
<b>4. Operations</b> .....	<b>8</b>
4.1. Short Overview, Operating .....	8
4.2. General .....	9
4.3. Switching On The DCU .....	9
Self-Testing .....	9
4.4. Functions Of The Keys .....	10
4.5. LC-Display .....	11
4.6. Symbol Definitions .....	12
4.7. LED Display .....	13
4.8. The Serial Interface .....	13
<b>5. Error Codes</b> .....	<b>13</b>
5.1. General .....	13
5.2. Errors During Self-Testing .....	13
<b>6. What To Do In Case Of Breakdowns ?</b> .....	<b>14</b>
<b>7. Maintenance, Service</b> .....	<b>14</b>
<b>8. Technical Data</b> .....	<b>15</b>
8.1. Data List .....	15
8.2. Dimensions .....	15
<b>9. Supplementary Informations</b> .....	<b>16</b>
<b>Manufacturer's Declaration</b> .....	<b>Appendix 1</b>

# 1. Safety Instructions

---

- ☞ Read and follow all instructions in this manual.
- ☞ Inform yourself regarding
  - Dangers which can arise from the unit;
  - Dangers which can arise from the system;
- ☞ Follow the safety and accident prevention instructions.
- ☞ Check regularly that all safety and protection requirements are being observed.
- ☞ When installing the DCU, take account of the ambient conditions.

The protection type is IP 20. The units DCU are protected against the ingress of foreign bodies  $\leq \varnothing 12$  mm. Since water protection is not provided, the unit should be mounted in a suitable housing (see Section 3. "Installation").
- ☞ Do not carry out any unauthorised modifications or alterations to the DCU.
- ☞ Do not open the housing cover when the unit is connected to the mains nor during pumping operations.
- ☞ Take account of the prescribed mains voltage values when connecting units DCU 100 to DCU 600.
- ☞ When shipping, please note the instructions in Section 7.

## Pictogram definitions:



There is danger of an electric shock if the contacts are touched.



There is danger of personal injury.



There is danger of damage to the unit or to the system.

## **2. Understanding The Display and Operating Unit DCU** ▬

### **2.1. For Your Orientation**

#### **Symbols used**

The following symbols will be used in the illustrations throughout the manual:



Electrical connection

#### **Abbreviations used**

TMP = Turbomolecular Pump  
DCU = Display and Operating Unit  
TC = Electronic Drive Unit  
TPS = Mains Power Unit

#### **Position numbers**

The same accessory parts have the same position numbers in all illustrations.

#### **Operation instruction in the text**

➔ Here, you must do something.

### **2.2. Product Description**

The Display Control Unit DCU is an operating unit for PFEIFFER drive units. It enables control over all the main parameters of the unit. Additionally, the connection of a vacuum gauge is possible.

DCU 001 = Basic unit without mains power unit  
DCU 100/150/200/300/600 = Unit with mains power unit.

#### **Mechanical Design**

The DCU is fitted in a housing suitable for mounting in a 19"/3HE rack.

#### **Connection Options**

The DCU provides the following connection options:

- Electronic drive unit for turbopump (X2)
- Pressure gauge (X3).
- Serial interface RS 485.

The units DCU 001, DCU 100 - DCU 600 have been tested and passed by the authorities in accordance with EN 61010/VDE 0411 "Safety Equipment For Electrical Units".

## Proper Use

- The display and operating unit DCU may only be used to control PFEIFFER Electronic Drive Units and their peripheral units.
- Instructions concerning installation, start-up, operating and maintenance must be observed.

## Improper Use

Improper is:

- Uses not covered above, especially:
  - Connection to pumps and units which is not permitted in their operating instructions.
  - Connection to units which contain touchable and voltage carrying parts.

Improper use will cause any rights regarding liability and guarantees to be forfeited.

## 2.3 Front panel

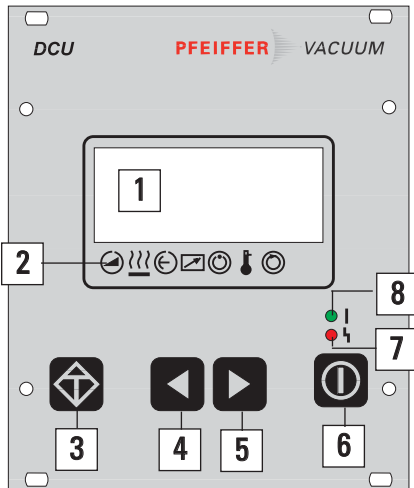

The front panel contains all the operating and display elements.

- 1 LCD display
- 2 Status display (symbol definitions see chapter 4.6.)
- 3 "Error acknowledgement" key
- 4 Key "Left"
- 5 Key "Right"
- 6 "Pumping Station ON/OFF" key
- 7 Red illuminating diode for error status
- 8 Green illuminating diode for operating status

## 2.4 Rear Panel

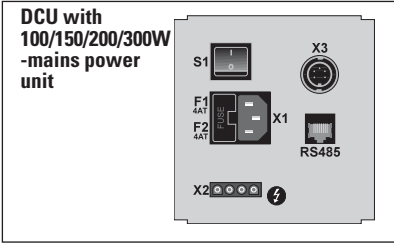

- S1 Mains switch
- F1 Mains fuse
- F2 Mains fuse
- X1 Mains connection 90-265 V~
- X2 Output for voltage supply, electronic drive unit
- X3 Pressure gauge connection
- RS 485 Communication with electronic drive unit

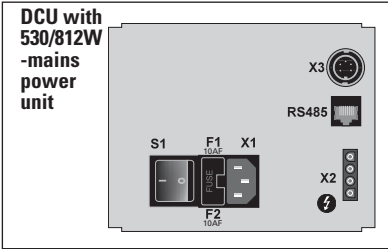

- S1 Mains switch
- F1 Mains fuse
- F2 Mains fuse
- X1 Mains connection 90-265 V~
- X2 Output for voltage supply, electronic drive unit
- X3 Pressure gauge connection
- RS 485 Communication with electronic drive unit

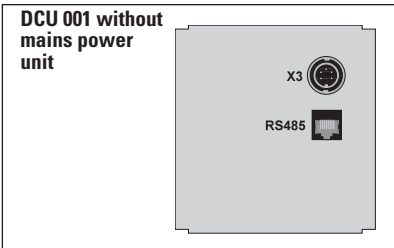

- X3 Pressure gauge connection
- RS 485 Communication with electronic drive unit

## 3. Installation

### 3.1. Preparations For Installation



Unauthorised modifications or alterations to the Display Control Unit are not allowed.

The unit must be fitted in a housing taking account of the ambient conditions (see section "Technical Data").

➔ Disconnect mains power plug before installation work.

**Installation location:** Protected against the weather.

The following is applicable for open buildings and operations rooms which are not fully air conditioned:

**Temperature:** +5°C - +40°C.

**Relative humidity:** 5 - 85%, non-condensing.

**Air pressure:** 86 kPa - 106 kPa

### 3.2. Rack Fitting

The units DCU 001, DCU 100 - DCU 600 are designed to be fitted into a 19"/3HE rack with guide rails.

➔ For installation secure the front panel to the rack using four fixing screws.

➔ Ensure free convection. The minimum distance to the upper and lower ventilation slits must be  $\geq 50$ mm.

The ambient temperature in the rack housing must not exceed 40°C.

Depending on the version, various connections are provided on the DCU.

### 3.3. Connecting Diagram

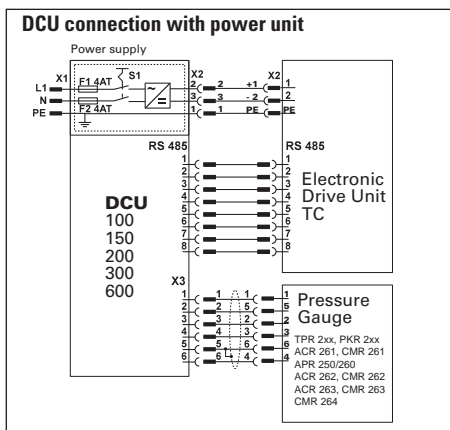
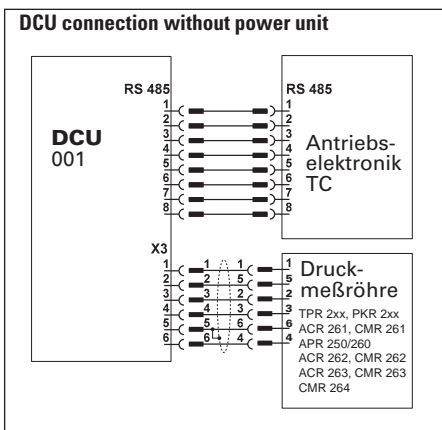

### 3.4. Making The Connections

- The units DCU 100 - DCU 600 have been designated protection class 1 and must always be connected with the earthed conductor (PE) via the mains cable.

Please note: If using the TC 600 electronic drive unit, please disconnect the remote plug from the RS 485 interface connection.

- ➔ Mains connection must be made in accordance with the local regulations.
- ➔ Make the connection X2 - Electronic Drive Unit in accordance with the connecting diagram, section 3.3.
- ➔ Make the connection pressure gauge to X3 as required.
- ➔ Make the connection RS 485/DCU-RS 485/Electronic Drive Unit via the delivered 8 pole cable.

The DCU 001 is re-supplied with its operating voltage via the Serial Interface RS 485 cable from the Electronic Drive Unit. As soon as this unit is switched on, the DCU is supplied with voltage.

#### Mains voltage

DCU 100: 90 - 265V~, 125VA

DCU 150: 90 - 265V~, 170VA

DCU 200: 90 - 265V~, 230VA

DCU 300: 90 - 265V~, 330VA

DCU 600: 90 - 132/185-265V~, 590/900VA

## 4. Operations

### 4.1. Short Overview, Operating

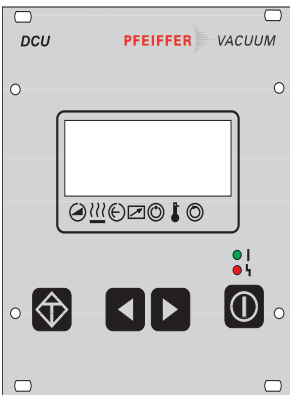

#### Selecting the parameters

- ➔ Select the parameter numbers with the keys ◀ (back) or ▶ (forward) (keeping the key depressed enables rapid scrolling).

#### Setting parameters

- ➔ Select a parameter.
- ➔ Depress keys ◀ and ▶ simultaneously.  
→ The arrow (--->) appears in the second line from the top.
- ➔ Reduce or increase the values with the key ◀ or ▶ respectively.
- ➔ Depress key ◀ and ▶ simultaneously.  
→ The arrow (--->) disappears.  
→ The parameter is set.



## 4.2. General

All function relevant aspects of the pump electronics are illustrated in the form of parameters. Each parameter has a number and a designation (for example, "720: Vent frequ").

The value of the parameter is always readable, in some cases also modifiable via the keyboard.

## 4.3. Switching On The Control Unit

➔ Make the connection to the Serial Interface RS 485.

### DCU 001:

➔ Switch on the external supply of the Electronic Drive Unit (for example TPS 100-600).

### DCU 100/150/200/300/600:

➔ Switch on the DCU by the switch S1 on the rear side.

➔ In the event of an error message: depress: .

## Self-Testing

After switching on, the DCU performs a self-test and also a test on the connected turbo electronics. Run time of the self-test: approx. 20s. During the test a bar appears in the display in line 4 and this shows the progress of this procedure.

- **Display test:** All signs in the LC display are shown for a short time in black.
- **LED test:** During the whole testing process the red and the green LEDs illuminate.
- **DCU test:** The DCU hardware is tested.
- **Connection to the turbo electronics test:** The correct connection to the turbo electronics and their identity are examined.
- **Parameter test:** Information regarding the parameters is loaded.
- **Identification of the connected components:** The designation of the drive unit is displayed.

Providing there are no errors the DCU is now ready to operate.

## 4.4. Functions Of The Keys

The four keys on the front panel have the following functions:

Key	Application/Example		Explanation
			<b>Reset</b> (error acknowledgement). Acknowledges errors (red LED illuminates)
		↶309: Act rotspd ↶310: TMP I-Mot	<b>Scroll back parameters</b> Scrolls back a parameter
	—>	↷871 Hz ↷ 872 Hz	<b>Reduce a value</b> (with arrow “—>”)
		↷310: TMP I-Mot ↷311: TMP Op hrs	<b>Scroll parameters forwards</b> Scrolls forward a parameter
	—>	871 Hz ↷ 872 Hz ↷	<b>Increases a value</b> (with arrow “—>”)
		001: Heating off	<b>Alters a value</b> (⇔ data editing mode) Access to a displayed value, if possible (arrow “—>” appears)
	simultaneously —>	001: Heating off ✓	<b>Confirm a value</b> (⇔ param. selection mode) Takes over an altered value (The arrow “—>” disappears)
	010: Pump stat. on ⇔ off		<b>Pumping Station ON/OFF</b> Switches the pumping station ON and OFF, equivalent to parameter 010: “Pump stat.”

## 4.5. LC-Display

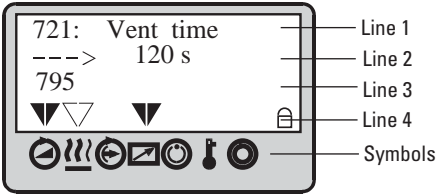

The functions are displayed via a four line LC display. A special function is assigned to each line:

- **Line 1:** Number and name of the selected parameter (for example 721: >>Vent time<<).
- **Line 2:** Relating value. If an arrow (--->) is displayed, the displayed value can be altered.
- **Line 3:** Two functions

**Function 1:** Messages relating to operations and operating are displayed. (see table “Operating Messages” in the operating instruction “Pumping Operations with DCU” and “Error Codes”, section 5).

**Function 2:** An optional second parameter in the form of >>Parameter number<< : >>value<< is displayed. The function of this line enables setting via parameter **[P:795]** >>Servicelin<< at line 1. With >>Servicelin<< all parameters can be displayed. Error messages are displayed independent of the selected function.

- **Line 4:** Arrows which points to the underlying symbol. This restores the unit status.







### Please note:

Prolonged depressing of the key  or  enables rapid scrolling and/or alterations to the data.

The data mode (arrow “--->” is displayed) is automatically relinquished, without taking over the values to be altered, under the following conditions:

- No settings or key depressing for longer than 10 seconds.
- The occurrence of an error.
- The key  has been depressed.

## 4.6. Symbol Definitions

	<b>Symbol</b>	<b>Arrow</b>	<b>Explanation</b>
	Pump	–	No
	accelerates	▼	yes
	Pre-selection	–	No pre-selection
	heating	▽	Pre-selection heating, but switchpoint not attained
		▼	Heating ON, switchpoint attained
	Stand-by	–	Off
		▼	On
	Unit under remote control	–	No
		▼	Yes
	Switchpoint attained	–	No
		▼	Yes
	Excess-temperature	–	No excess temperatures
		▼	Excess temperature pump
		▽	Excess temperature pump elektronik
		▼	Excess temperature pump and pump elektronik
	Final rotation speed attained	–	No
		▼	Yes

## 4.7. LED Display

The red LED (error status) and green LED (operations status) on the front panel can take on the following conditions:

### Red LED

Illuminates: Collective error messages  
Flashes: Warning

### Green LED

Illuminates: Mains power unit OK, pumping station ON  
Flashes: Mains power unit OK, pumping station OFF  
Blinks: Mains power failure

## 4.8. Serial Interface

The serial Interface RS 485 is only used for connecting the pump controller at the vacuum pump. The description of the interface protocol you can find in the operating instruction PM 800 488 BN.

## 5. Error Codes

### 5.1. General

Errors ("Errxxx" or "Error Exxx") always causes to shut-down of the TMP, the fan, the heating and the backing pump.

➔ After the error is removed depress key .

→ The unit is again ready to operate.

Warnings ("Wrnxxx" or "Warning Fxxx") are only displayed and do not cause components to be shut down.

### 5.2. Errors During Self-Testing

The following errors can occur during self-testing performed when the DCU is switched on:

Display	Error	Possible action
** Error E021 **	• Wrong pump identification resistance	• Mains OFF-ON • Inform PFEIFFER-Service
** Error E040 **	• Hardware error: external RAM defective	• Inform PFEIFFER-Service
** Error E042 **	• Hardware error: EPROM checksum	• Inform PFEIFFER-Service
** Error E090 **	• Insufficient RAM • The DCU is connected to the wrong pump electronic	• Inform PFEIFFER-Service • Connect correct pump electronic
** Error E698 **	• The connected drive unit does not respond	• Check communication lead between electronic drive unit and DCU, switch on electronic drive unit

## 6. What To Do In Case of Breakdowns ?

---

### Check the fuses

In case of an error:

- ➔ Loosen F1/F2 with a screwdriver and check fuses. Replace if defective. Only use fuses with high switching capability.

The safety values are stated on the rear panel of the DCU.



Caution! Double pole / neutral fusing!

## 7. Maintenance And Service

---

The unit requires no maintenance. A damp cloth can be used to wipe away any dirt which has collected on the front panel. Ensure that the unit is first disconnected from the mains power supply.

### Do Make Use Of Our Service Facilities

In the event that repairs are necessary a number of options are available to you to ensure any system down time is kept to a minimum:

- Have the unit repaired on the spot by PFEIFFER Service Engineers;
- Return the unit to the manufacturer for repairs;
- Replace with a new value unit.

Local PFEIFFER representatives can provide full details.



When carrying out their own repairs customers must bear in mind that dangerous voltage levels are present.

### Please note:

Units returned to us for repair or maintenance are covered by our general conditions of sale and supply.

### Contact addresses and telephone hotline:

Please refer to the back cover of this manual for contact addresses and telephone hotline numbers.

## 8. Technical Data

### 8.1. Data List

Definition	Unit	DCU 001	DCU 100	DCU 150	DCU 200	DCU 300	DCU 600
Connection voltage:	V DC	12-30 <sup>1)</sup>	–	–	–	–	–
	V AC	–	90-132	90-132	90-132	90-132	90-132
	V AC	–	185-265	185-265	185-265	185-265	185-265
Frequency:	Hz	–	50-60	50-60	50-60	50-60	50-60
Max. power consumption.:	VA	≤ 5	≤ 125	≤ 170	≤ 230	≤ 350	590/900 <sup>2)</sup>
Output voltage X2:	VDC	–	24	24	48	72	140
Max output current X2:	A	–	4,1/4,6 <sup>2)</sup>	5/6,2 <sup>2)</sup>	4,1/4,6 <sup>2)</sup>	3,2/4,2 <sup>2)</sup>	3,8/5,8 <sup>2)</sup>
Max output power X2.:	W	–	100/110 <sup>2)</sup>	120/150 <sup>2)</sup>	200/220 <sup>2)</sup>	230/300 <sup>2)</sup>	530/812 <sup>2)</sup>
permis. amb. temperature.:	°C	5 - 40					
Max. relative humidity. <sup>3)</sup>	%	5 - 85					
Air pressure:		86kPa - 106 kPa					
Protection type:		IP 20					
Weight:	kg	0,4	1,6	1,9	1,9	2,2	2,6

1) only supplied by PFEIFFER Electronic Drive Unit  
 2) at 90-132 V AC / 185-265 V AC  
 3) non condensing

### 8.2. Dimesions

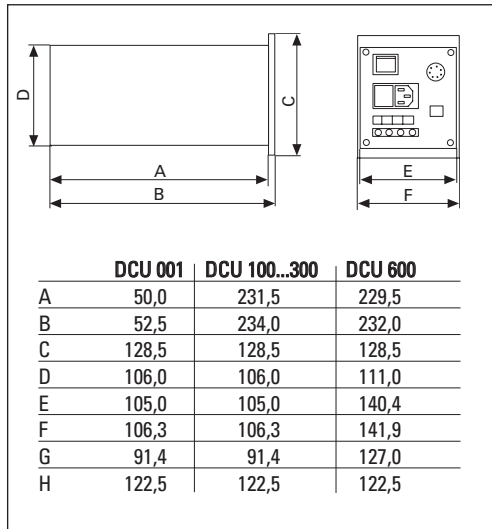
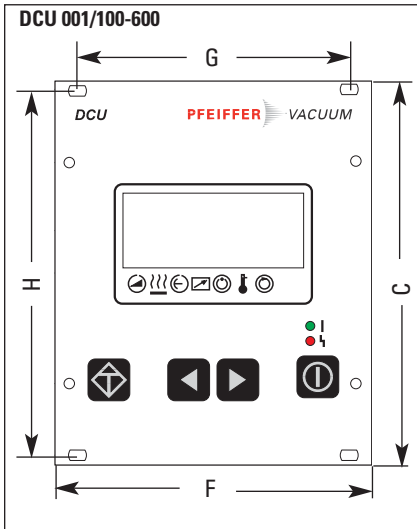

## 9. Supplementary Information

The Display And Control Unit DCU is a universal component for the control and monitoring of PFEIFFER vacuum pumps and drive units.

Depending on the configuration of your components further operating instructions are included in the delivery consignment (please see the table). If, despite every effort by us, information on your products is missing please get in touch with your local Pfeiffer representatives or call us on the hotline shown on the back cover page. All operating instructions are also available as PDF files.

The following operating instructions are available for the range of pumps which come with DCU control units:

Product	Definition	No. Operating Instruction
Vacuum pump	Description of the Pump	dependent to the pump typ <sup>1)</sup>
DCU 001, 100-600	Description of the controller	PM 0477 BE
Operating turbo pump with DCU	Operating definition/parameter	PM 0547 BE
TPS 100, 200, 300, 600	Description of the mains power unit	PM 0521 BE
Housing heating turbo pump	Description of the housing heating	PM 0542 BE
Air cooling turbo pump	Description of the air cooling	PM 0543 BE
Water cooling turbopump	Description of the water cooling	PM 0546 BE
Backing pump relay box <sup>2)</sup>	Description monitoring of the backing p.	PT 0030 BE
Temperature Management System TMS	Description heating of the pre vacuum section of the turbo pump	PT 0099 BE
RS 232/485	Pfeiffer Vacuum Protocol	PM 0488 BE
RS 232/485	Description of the interface	PM 0214 BE
Level converter RS 232/RS 485	Pump monitoring via RS 232	PM 0549 BE
TVF 005	Description of the vent valve	PM 0507 BE

<sup>1)</sup> Numbers can be supplied by PFEIFFER Service.  
<sup>2)</sup> Only for rotary vane vacuum pumps.





# Vacuum is nothing, but everything to us!



**Turbo Pumps**



**Rotary Vane Vacuum Pumps**



**Roots Pumps**



**Dry Vacuum Pumps**



**Leak Test Units**



**Valves**



**Flanges, Feedthroughs**



**Vacuum Measurement**



**Gas Analysis**



**System Technology**



**Service**

**PFEIFFER**  *VACUUM*

Pfeiffer Vacuum Technology AG · Headquarters/Germany  
Tel. +49-(0) 64 41-8 02-0 · Fax +49-(0) 64 41-8 02-2 02 · info@pfeiffer-vacuum.de  
www.pfeiffer-vacuum.net