

MLA150

The Advanced
Maskless Aligner

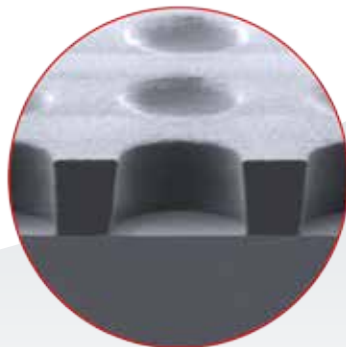

MLA150 THE MASKLESS ALIGNER

The Maskless Aligner MLA150 takes you into the future of photolithography: The traditional photomask becomes a thing of the past as your design file is exposed directly onto the resist-coated wafer via a 2-dimensional Spatial Light Modulator.

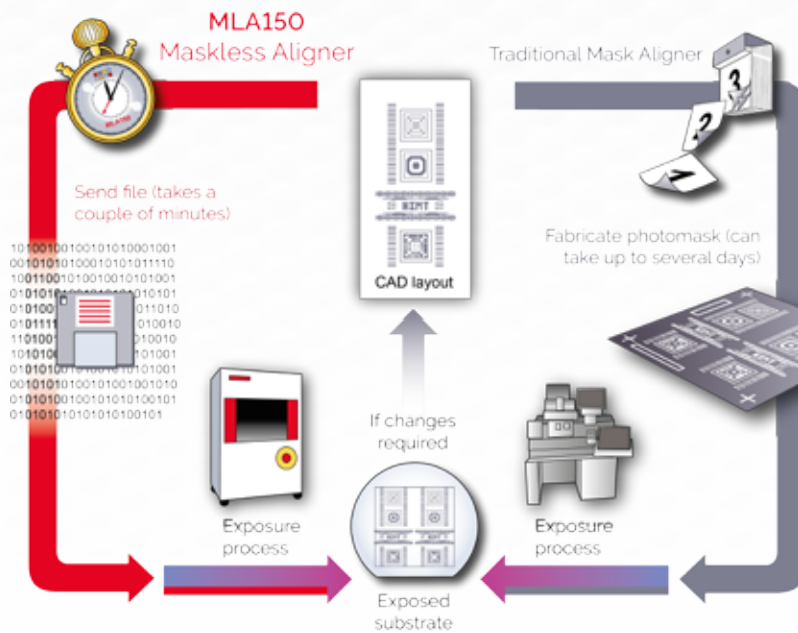

In addition to flexibility and economy, MLA150 provides non-contact exposure, outstanding ease of use, and high speed, making it the ideal tool in rapid prototyping environments, for low- to mid-volume production, and Research & Development.

The Maskless Aligner was first introduced in 2015. Since then, the revolutionary, state-of-the-art maskless technology has become firmly established. Today, the MLA150 serves as a trusted, indispensable workhorse in many multi-user facilities, nanofabrication labs, and national institutes. Application areas include MEMS, micro-optics, diffractive optical elements, sensors, electronic components and many more.

SPEED

- High-speed Spatial Light Modulator (SLM)
- Bidirectional writing process
- „Empty stripes“ optimization
- Ultra-fast x-y stage

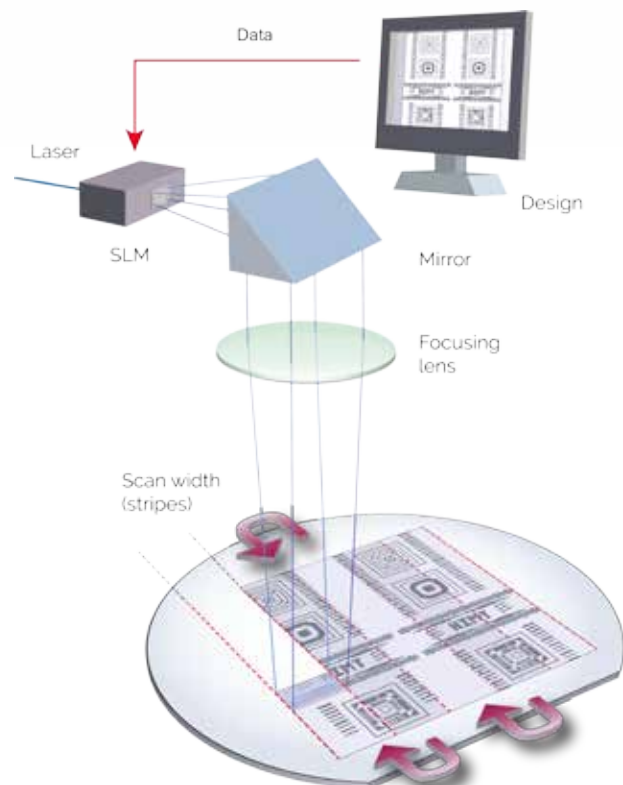

MLA150 exposure times ★

Laser wavelength	405 nm
50 x 50 mm ²	4 minutes
100 x 100 mm ²	9 minutes
150 x 150 mm ²	16 minutes
200 x 200 mm ²	36 minutes

★ For exposure at 100 mJ/cm² and minimum feature size of 1 μm

HIGH RESOLUTION

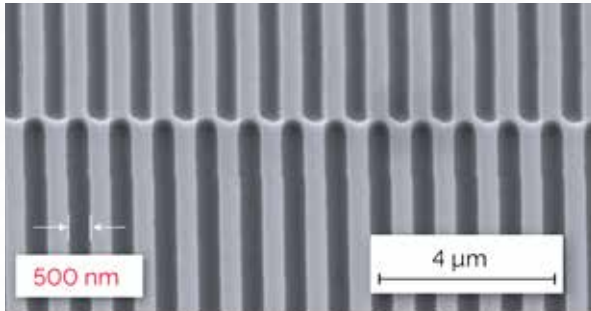

High-resolution mode: Vertical 500 nm lines and spaces. Resist: S1805. Wavelength: 375 nm

HIGH-ASPECT-RATIO

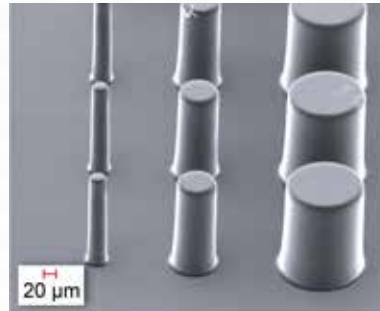

High-aspect ratio: Pillars. Resist: 160 μm SU-8

- Adjustable depth of focus
- Aspect ratio up to 1:20
- Applications: Micro-fluidics, MEMS, waveguides

FAST AND HIGH-PRECISION ALIGNMENT

- Global and field-by-field alignment
- Backside alignment
- Alignment accuracy of better than 500 nm
- Fast and easy alignment procedure
- Alignment error compensation: Corrects for rotation, offset, scaling and shearing
- Allows mix and match between different tool sets, e.g. e-beam or thermal scanning probe lithography and laser lithography

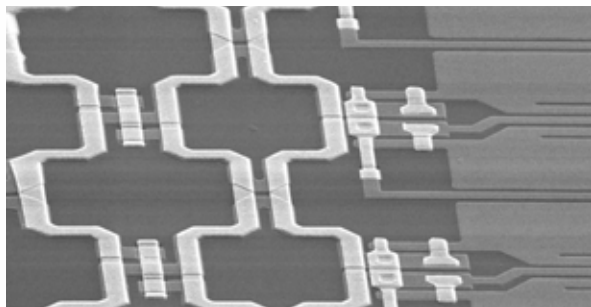

SQUID magnetic flux sensor; 18 layer process

Courtesy of the Kirchhoff Institute for Physics, Heidelberg

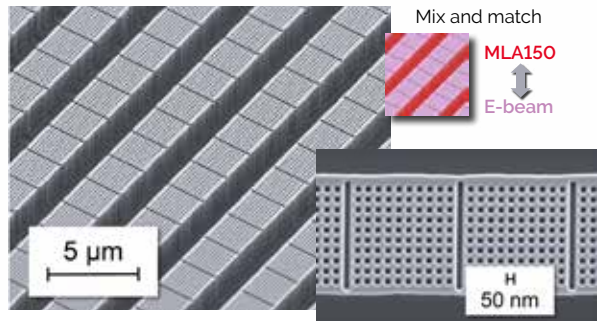

Mix and match lithography

Courtesy of EPFL LMIS1, Lausanne

FLEXIBILITY

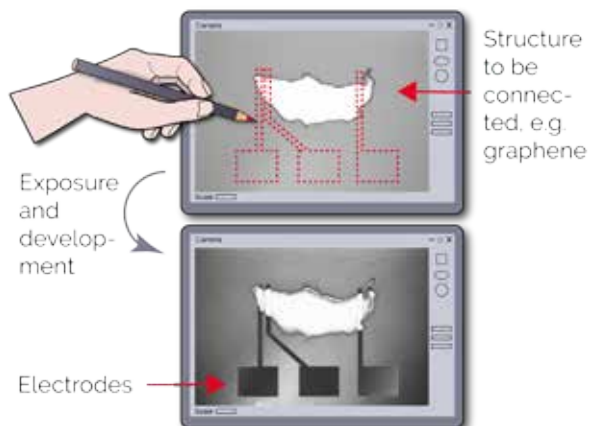

- The available solid state laser sources (405 and 375 nm) make the system compatible with all broadband UV photoresists (including SU-8) and can both be installed in the MLA150 at the same time
- 3D-patterning with grayscale lithography
- Optional: exchangeable chucks with individual vacuum layouts
- The Draw Mode: Add individual features to a previously patterned substrate. Using graphic elements, or even a bitmap, simply „draw“ the desired structures - such as labels, markers, or electrical connections - directly into the camera image

MLA150

SYSTEM SPECIFICATIONS

	Write Mode I ★	Write Mode II ★
Writing performance		
Minimum structure size [µm]	0.6	1
Linewidth variation [3σ, nm]	100	120
Global 2nd layer alignment [3σ, nm]	500	500
Local 2nd layer alignment [3σ, nm]	250	250
Backside alignment [3σ, nm]	1000	1000
Exposure time 405 nm laser for 4" wafer [min]	35	9
Exposure time 375 nm laser for 4" wafer [min]	35	20
Max. write speed 405 nm laser [mm ² /min]	285	1100
Max. write speed 375 nm laser [mm ² /min]	285	500
System features		
Light source	Diode lasers: 8 W at 405 nm, 2.8 W at 375 nm, or both	
Substrate sizes	Variable: 3 x 3 mm ² to 6" x 6" Optional: 8" x 8" Customizable on request	
Substrate thickness	0 - 12 mm	
Maximum exposure area	150 x 150 mm ² Optional: 200 x 200 mm ²	
Temperature controlled flow box	Temperature stability ± 0.1°	
Real-time autofocus	Air-gauge or optical	
Autofocus compensation range	180 µm	
Grayscale	128 gray levels	
Software features	Exposure wizard, resist database, automatic labeling and serialization, Draw Mode for CADless exposures, substrate tracking / history	
System dimensions (lithography unit)		
Height x width x depth	1950 mm x 1300 mm x 1300 mm	
Weight	1100 kg	
Installation requirements		
Electrical	230 VAC ± 5%, 50/60 Hz, 16 A	
Compressed air	6 - 10 bar, stability ± 0.5 bar	
Economical considerations		
Saves on the cost of photomasks		
Low running costs for maintenance, energy consumption, spare parts		
Solid state laser light sources with lifetime of several years		

★ Only one write mode can be installed on the system

Please note: Specifications depend on individual process conditions and may vary according to equipment configuration. Write speed depends on exposure area. Design and specifications are subject to change without prior notice.

WORLDWIDE SALES OFFICES

To contact your local representative please consult our website www.himt.de or email us at info@himt.de

