



PPMS[®] Platform
Measurement Options

Table of Contents

PPMS Family

DynaCool	2
PPMS with EverCool II	2
VersaLab	2

Electrical Transport

AC Resistance (ETO)	3
DC Resistance	4
Pressure Cell (Transport)	5
Horizontal Rotator	6

Magnetometry

Vibrating Sample Magnetometer (VSM)	7
VSM Large Bore Coil Set	8
VSM Oven	9
FORC Software for VSM	10
Fiber Optic Sample Holder (FOSH)	11
Pressure Cell (Magnetometry)	12
Torque Magnetometer	13
AC Susceptibility (ACMS II)	14

Thermal Measurements

Thermal Transport (TTO)	15-16
Heat Capacity	17
Dilatometer	18

Sub-Kelvin Capabilities

Adiabatic Demagnetization Refrigerator (ADR)	19
Helium-3 Refrigerator	20
Dilution Refrigerator	21
Sub-Kelvin Measurement Options	22-23

Multi-Function Probes

Multi-Function Probe (MFP) Types	24
Optical Multifunction Probe (OMFP)	25-26

Raman Spectroscopy	27-28
---------------------------	-------

Light Sources	29
----------------------	----

Compatibility Tables	30
-----------------------------	----

PPMS Family

The Quantum Design Physical Property Measurement System (PPMS) represents a unique concept in laboratory equipment: an open architecture, variable temperature and magnetic field system, designed to perform a variety of automated measurements. Use the PPMS with its many purpose-built measurement options, or easily adapt it to your own experiments. These systems provide sample environments from 0.05 to 1000 K and fields up to 16 tesla.

PPMS® DynaCool™

The popular PPMS is now available in a truly state-of-the-art cryogen-free package. The PPMS DynaCool uses a single two-stage Pulse Tube cooler to cool both the superconducting magnet and the temperature control system, providing a low vibration environment for sample measurements. The PPMS DynaCool offers continuous low temperature control, precise field and temperature sweep modes, as well as a built-in cryopump.

PPMS® EverCool II™ Option

The PPMS from Quantum Design is now available in a cryogen-free package. The cryogen-free PPMS EverCool II option is available as a new system or an upgrade for existing wet PPMS systems. This option recondenses helium gas boil-off to allow cryogen-free operation.

PPMS® VersaLab™

The PPMS VersaLab is a portable, cryogen-free, cryocooler-based material characterization platform. With a temperature range of 50 to 400 K, this 3 tesla platform is perfect for accomplishing many types of materials characterization in a limited space, with no requirements for cryogenic liquids or high power infrastructure.



Specifications

DynaCool

Temperature Range*	1.8 to 400 K
Temperature Stability:	± 0.1% (T < 20 K), ± 0.02% (T > 20 K); (typical)
Temperature Accuracy:	± 1%
Cool Down Time:	40 minutes (typical; time to stable 1.9 K from 300 K)
Field Range:	± 9 T, ± 12 T, ± 14 T
Field Uniformity**:	9 T: ± 0.01% over 3 cm on-axis 12 T: ± 0.1% over 5.5 cm on-axis 14 T: ± 0.1% over 5.5 cm on-axis
Field Resolution:	9 T: ± 0.16 G 12 T: ± 0.22 G 14 T: ± 0.22 G
Max Field Charging Rate:	200 Oe/s
Min Field Charging Rate:	0.1 Oe/s
High Vacuum:	< 0.1 mTorr

PPMS

Temperature Range:	1.9 to 400 K
Temperature Stability:	± 0.2% (T < 20 K), ± 0.02% (T > 20 K); (typical)
Temperature Accuracy:	± 1%
Temperature Sweep Rate:	6 K/min. cooling, 10 K/min. warming; (typical)
Cool Down Time:	40 minutes (typical time to stable 1.9 K from 300 K)
Field Range:	± 9 T, ± 14 T, ± 16 T
Field Uniformity**:	9 T: ± 0.01% over 5.5 cm on-axis 14 T: ± 0.1% over 5.5 cm on-axis 16 T: ± 0.1% over 1.0 cm on-axis
Max Field Charging Rate:	9 T: 190 Oe/s (> 1 T/min.) 14 T: 160 Oe/s (≈ 1 T/min.) 16 T: 160 Oe/s (≈ 1 T/min.)
Min Field Charging Rate:	0.1 Oe/s
High Vacuum (optional)	0.1 mTorr

PPMS EverCool II

Specifications identical to standard PPMS with the following additions:

Field Range:	± 9 T only
He Liquefaction Rate:	8 liquid liters / day; typical without additional heat load (equiv. 5 gaseous liters / minute)
He Consumption Rate:	300 gaseous liters / day (equiv. 1 "A" size cylinder / month)
Liquid Helium Capacity:	4 liters maintained under normal operating conditions; 6 liters total

VersaLab

Temperature Range:	50 to 400 K
Temperature Stability:	± 0.02%
Temperature Accuracy:	± 1%
Cool Down Time***:	< 120 minutes (time to stable 50 from 300 K)
Field Range:	± 3 T
Field Uniformity**:	± 0.1% over 2.5 cm on-axis
Max Field Charging Rate:	300 Oe/s
Min Field Charging Rate:	0.1 Oe/s
High Vacuum:	< 1 mTorr

*Stated 1.8 K is for 60 Hz line frequency; 50 Hz line frequency has a base of 1.85 K.

**Uniformity range is centered 4.05 cm above the surface of a standard transport puck; this point represents the center of an installed VSM coilset.

***Stated 120 minute cool down time is for 60 Hz line frequency; 50 Hz line frequency has a cool down time of 140 minutes.

Specifications are subject to change without notice.

Electrical Transport

AC Resistance (ETO)

DynaCool (D605) / PPMS (P605) / VersaLab (V605)

The Electrical Transport Option (ETO) leverages a digital lock-in technique to measure resistance in a traditional Kelvin sensing (4-probe) configuration across a wide dynamic range; this is extended further by the special 2-probe high-impedance mode for a total range spanning nearly fifteen full decades. The two modes feature 8 MΩ of overlap so data can be normalized for a complete curve across both ranges. Additional functions like I-V curve profiling and differential resistance measurements extend the utility of the ETO to non-ohmic materials as well as device characterization and screening.

Key Features:

- Simultaneous measurement of resistance on up to two channels with phase angle and quadrature voltage reported for diagnostics
- Pre-selected frequencies for channels 1 and 2 prevent cross-talk and maximize signal-to-noise
- Two measurement modes: current sourced in standard 4-probe configuration; voltage sourced in high-impedance 2-probe configuration
- I-V curve collection can be used to screen for ohmic contacts
- Preamp is mounted as close to the electrical access point of the PPMS as possible to minimize degradation of small signals occurring before amplification

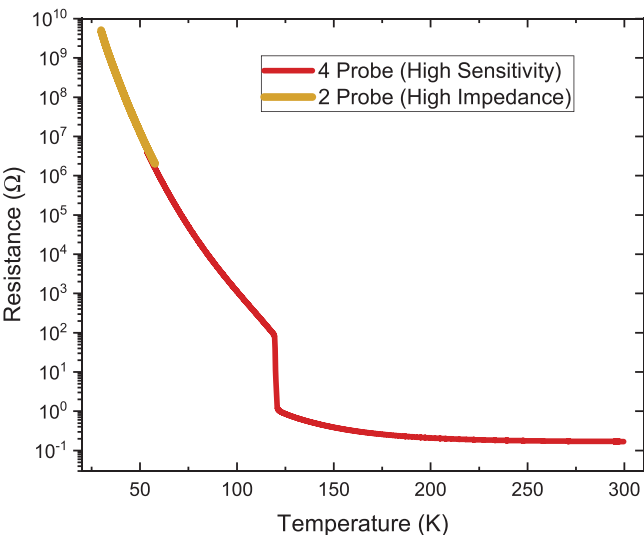

Temperature dependence of the resistance of a magnetite (Fe_3O_4) mineral sample. The high-resistance data is collected using the 2-probe (high impedance) mode, while the rest of the range is covered by the more conventional 4-probe configuration for increased sensitivity. Note that the Verwey transition can be resolved near 120 K.

Electrical Transport (ETO) Specifications (for zero-field) (Values refer to the standard 4-probe configuration unless otherwise noted)

Resistance [R]

Excitation Mode:	AC
Range:	10 $\mu\Omega$ to 10 M Ω 2 M Ω to 5 G Ω (high-impedance 2-probe)
Accuracy*:	$\pm 0.1\%$ typical, $\pm 0.2\%$ maximum; $R < 200$ k Ω $\pm 0.2\%$ typical; $R \approx 1$ M Ω $\pm 2.0\%$ typical; $R < 1$ G Ω (high-impedance $\pm 5.0\%$ typical; $R = 5$ G Ω (high-impedance 2-probe)
Sensitivity:	10 n Ω RMS typical

Drive Parameters

Frequency Range:	0.1 to 200 Hz (nominal)
Current Amplitude Range**:	10 nA to 100 mA
Current Amplitude Accuracy:	$\pm 0.4\%$, 100 nA drive; improves for larger amplitudes
Voltage Amplitude Range:	10 mV to 10 V (high-impedance 2-probe)

Operational Range 1.8 to 400 K; 0 to 16 T

*Accuracy specification depends on sourced current and selected preamp range; stated values describe typical performance for a majority of possible measurement configurations.

**Stated available current range applies to operation at temperatures of 1.8 K and above.

Specifications are subject to change without notice.



ETO Preamp Head

Electrical Transport

DC Resistance

DynaCool (D400) / PPMS (P400) / VersaLab (V400)

DC transport for up to three channels on a standard puck can be measured using the DC Resistivity Option for the PPMS. Bridge channels can be individually configured for various levels of current excitation or power limitation, as well as enabling automated polarity-switch averaging to remove static DC offset voltages.

Key Features:

- Three multiplexed four-probe measurement channels accessible on a single puck
- Optional fourth channel for customized measurements
- Configurable bridge parameters to limit the voltage, current, or power at the sample for protecting sensitive devices, films, etc.
- Resistivity can be calculated using measured resistance from user-provided sample geometry parameters

DC Resistivity Specifications (for zero-field)

Resistance [R]

Excitation Mode: DC
 Range: 10 $\mu\Omega$ to 5 M Ω
 Sensitivity: 15 nV RMS typical*

Drive Parameters

Current Range: 2 nA to 8 mA
 Compliance Voltage: 4 V, maximum
 Frequency: 5 Hz square wave

Operational Range 1.8 to 400 K; 0 to 16 T

*This corresponds to 2 $\mu\Omega$ at 8 mA excitation.
 Specifications are subject to change without notice.

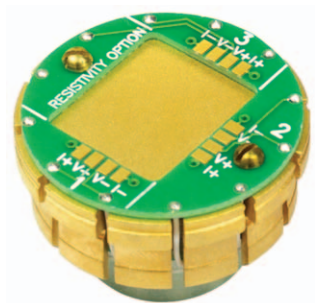

Resistivity Puck



Optional P101 Universal Sample Puck



Sample Wiring Test Station

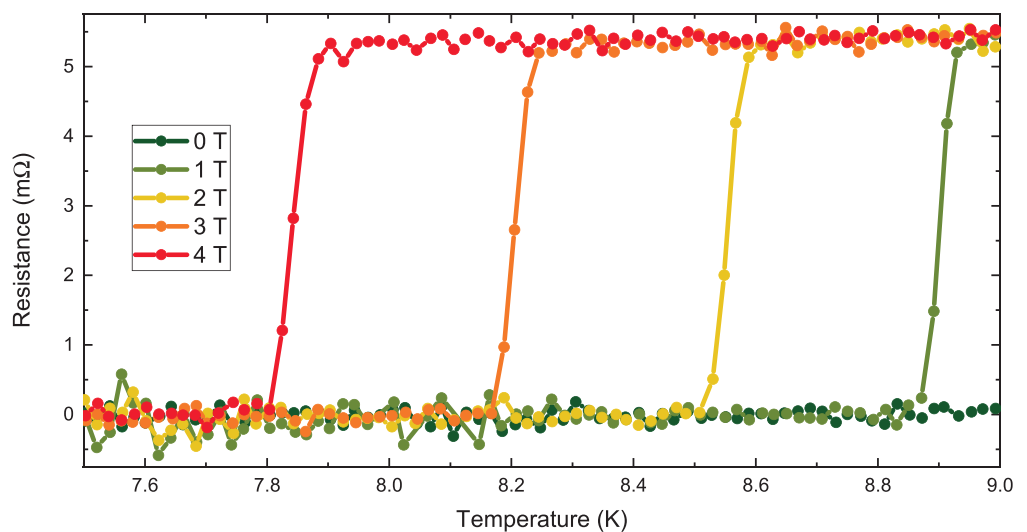

The superconducting transition in a NbTi alloy is shown for a number of fixed magnetic fields demonstrating the field-dependence of T_c .

Electrical Transport

Pressure Cell (Transport)

DynaCool (D420) / PPMS (P420) / VersaLab (V420)

Often a sample's electrical transport properties evolve under the application of substantial hydrostatic pressure. The Transport Pressure Cell Option for the PPMS is manufactured by ElectroLab, a leading Japanese supplier of pressure cells. It enables up to two 4-probe measurements (typically for the sample and a manometer) of electrical transport at pressures as high as 2.7 GPa. Samples are mounted to pre-made sets of electrical leads with integrated feedthroughs for pressurization in an oil media using a bench-top press to apply load.

Key Features:

- Complete kit includes required tools and materials for mounting samples, applying pressure to the cell, and measuring pressure
- Includes manometer materials of tin and lead, whose superconducting transition temperatures can be accurately measured via integrated thermometry which can be used to infer actual cell pressure
- Cell can be installed in the PPMS using standard puck insertion/extraction tool
- Data can be collected with any PPMS-compatible QD transport option
- 10 total sample leads (5 twisted pairs) included with each feedthrough set

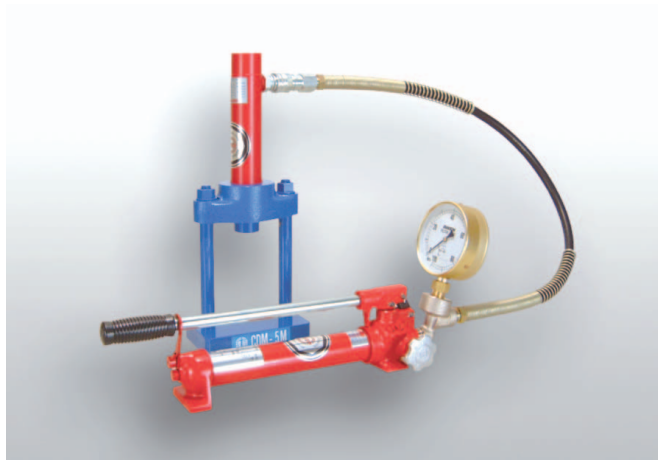

Press specifications

Model	CDM-5PAS (5 ton)	CDM-10PAS (10 ton)
Maximum pressure	70 MPa	70 MPa
Bore area	7.16 cm ²	14.52 cm ²
Mass	10 kg	25 kg

Optional – digital pressure gauge

Pressure Cell (Transport) Specifications

Pressure [P]

Maximum Sample Pressure: 2.7 GPa
Maximum Applied Load: 3.0 GPa

Sample Space Parameters

Diameter: 4 mm
Length: 6 mm

Operational Range

1.8 to 400 K; 0 to 9 T

Specifications are subject to change without notice.



High Pressure Cell for Electric Transport Measurements

Electrical Transport

Horizontal Rotator

DynaCool (D310) / PPMS (P310) / VersaLab (V310)

Probing the angular dependence (i.e. anisotropy) of the electrical resistance provides key insights into the electronic and crystallographic properties of materials. The Horizontal Rotator enables a sample to be rotated over 360° in the presence of an applied magnetic field spanning the entire temperature range of the base system. An automated indexing procedure and encoder ensures accurate angular positions and the on-board thermometer monitors the temperature in close proximity to the sample.

Horizontal Rotator Specifications

Angle [θ]

Range:	-10° to 370°
Angular Step Resolution*:	0.0133°/step (standard resolution) 0.0011°/step (high resolution)
Orientation:	Axis of rotation perpendicular to magnetic field axis <i>and</i> puck key
Backlash:	< 10°

Operational Range 1.8 to 400 K; 0 to 16 T

*Specified resolution is only obtained by driving successive steps in the same direction.

Specifications are subject to change without notice.

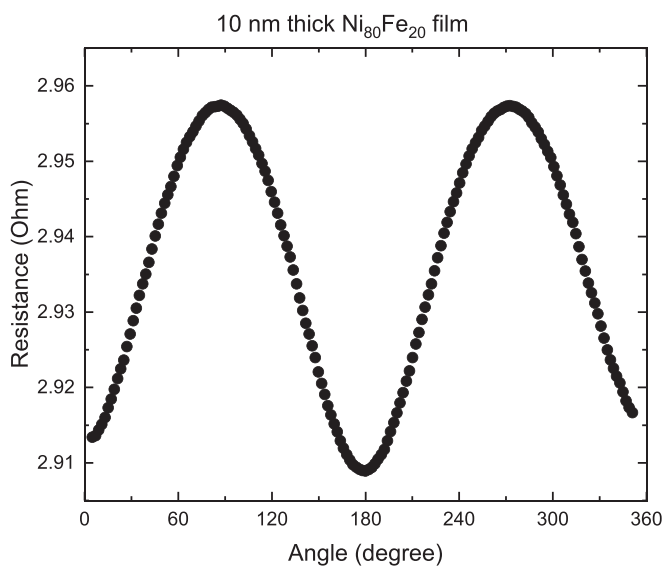

Angular dependence of magnetoresistance measured at 300 K and 1 T using the Resistivity Option in conjunction with the Horizontal Rotator. The 10 nm thick Permalloy film exhibits the expected anisotropic magnetoresistance (AMR) response.

Key Features:

- Integrated temperature sensor is in direct contact with the installed sample holder
- Materials chosen to minimize magnetic and temperature effects to ensure reproducibility upon cycling environmental parameters
- Two types of sample boards provided – one where the rotation axis remains in the sample plane, and one where the axis points out of the sample plane
- Two channels per sample board, each channel provides 4-probe electrical contacts
- Low- and high-resolution motor options available

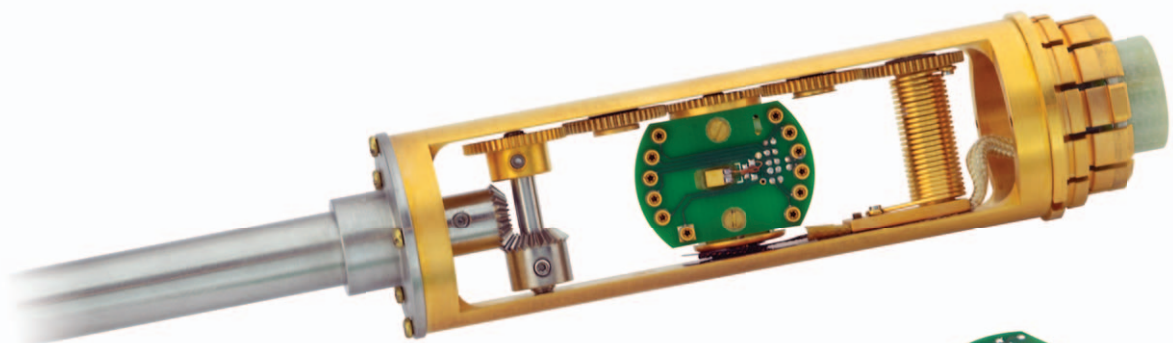

Horizontal Rotator, shown with sample boards designed for Resistivity/ETO (field parallel sample plane), Resistivity/ETO (standard), and the Universal Sample Board.

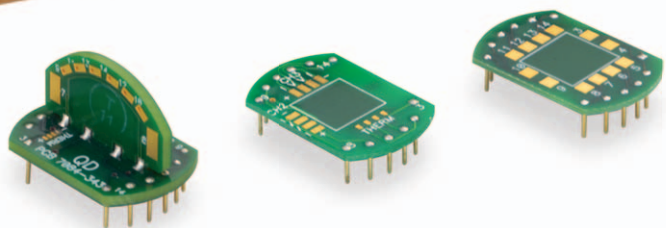

Magnetometry

Vibrating Sample Magnetometer (VSM)

DynaCool (D525) / PPMS (P525) VersaLab (V525)

The Vibrating Sample Magnetometer (VSM) option employs a puck-based first-order gradiometer coil set and high-resolution linear transport motor that enables the PPMS to operate as a sensitive magnetometer. The static (DC) magnetic moment of the sample can be measured as a function of temperature or field. With a typical 1 second averaging time per datum, data acquisition rates are comparatively fast. Furthermore, measurements as a function of sweeping the measurement temperature or field are possible. An included set of standard sample holders enable measurements of a wide variety of sample sizes and morphologies, such as: small single crystals, thin films (can be oriented with applied field in- or out-of film plane), sintered polycrystalline pieces, and loose powders.

Key Features

- Lock-in measurement technique isolates sample signal from external mechanical and electronic noise for precise measurement of sample moment
- Linear transport motor enables centering accuracy within ± 0.04 mm
- A temperature sensor integrated within the coil set provides sample thermometry via exchange gas coupling
- Standard sample holders included are a low-background quartz paddle and brass half-tube with quartz spacers and polycarbonate capsules

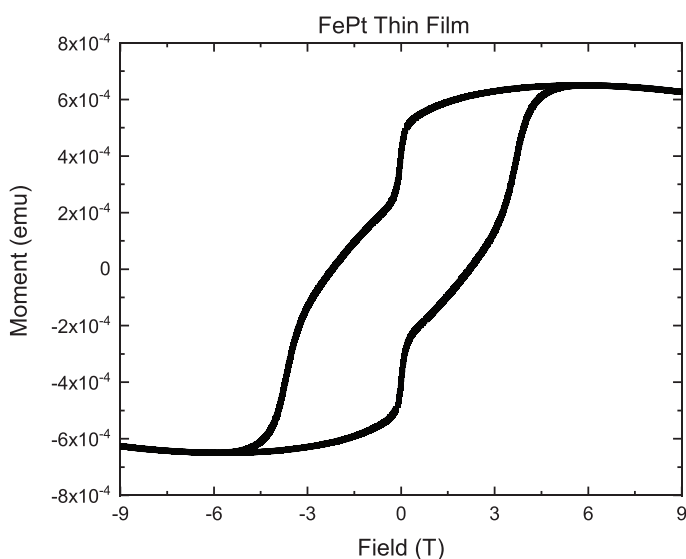

Room temperature major hysteresis loop of a high anisotropy FePt thin film with an in-plane saturation field of approximately 5 T and a coercivity of 2.2 T. Sample provided by Prof. Kai Liu, Georgetown University.

Vibrating Sample Magnetometer Specifications

(for standard bore in zero field, unless indicated)

Magnetic Moment [m]

Accuracy:	$\pm 0.5\%$, using 2.8 mm dia. \times 4 mm tall cylinder (shape of included Pd reference)
Noise Floor*:	$< 6.0 \cdot 10^{-7}$ emu @ 300 K
Additional Relative Noise*:	$3.0 \cdot 10^{-7}$ emu/T or 0.5%, whichever is greater $1.0 \cdot 10^{-6}$ emu/T or 0.5%, whichever is greater (EverCool II)
Max Measurable Moment:	m_{max} [emu] = 40/Peak Amplitude [mm]

Drive Parameters

Oscillation Amplitude:	0.1 to 5 mm peak, 2 mm (typical)
Oscillation Frequency:	10 to 60 Hz, 40 Hz (typical)
Averaging Time :	0.5 to 750 seconds, 1 second (typical)

Coil Set Dimensions

Bore Diameter:	6.3 mm
Coil Separation:	9 mm

Operational Range

1.8 to 400 K; 0 to 16 T

*Parameters are integration-time dependent; stated values are for integration times of 1 second at 40 Hz, 2 mm amplitude excitation. Total observed noise is the sum of the floor and relative components.

Specifications are subject to change without notice.

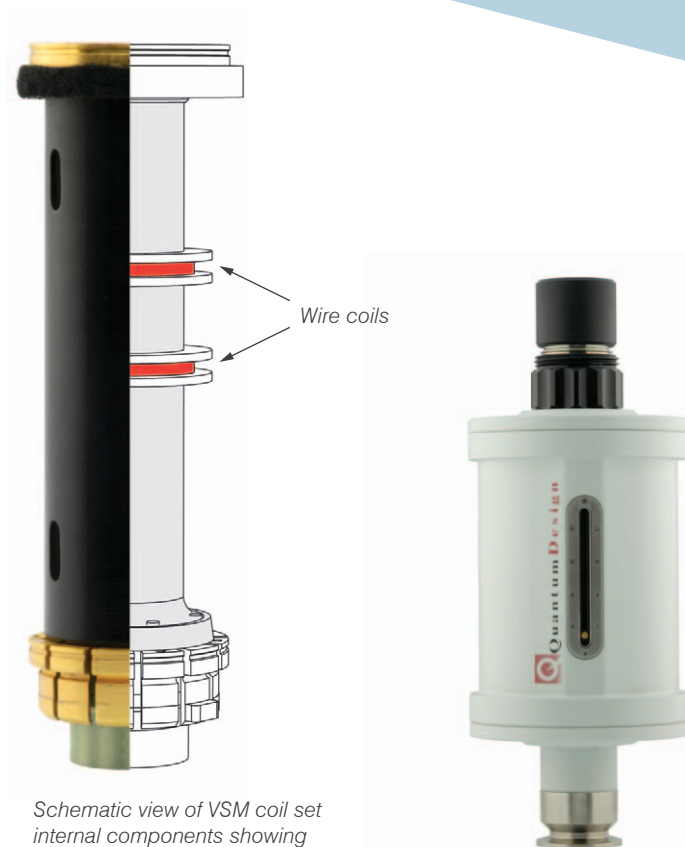

Schematic view of VSM coil set internal components showing the turns of wire comprising the first-order gradiometer.

Magnetometry

Large Bore Coil Set (VSM)

DynaCool (D529) / PPMS (P529) / VersaLab (V529)

The large bore coil (LBC) option extends the utility of the VSM by accommodating larger diameter sample holders (e.g., drinking straws, using the included straw adapter) and pressure cells. The static (DC) magnetic moment can still be measured both as a function of temperature or field using much of the same hardware, and an identical software interface, as the standard VSM setup.

Key Features:

- Greater flexibility in sample mounting techniques
- Ability to use drinking straws as sample holders
- Ability to use pressure cells for magnetic measurements at pressures up to 1.3 GPa
- Operation is identical to the standard VSM option

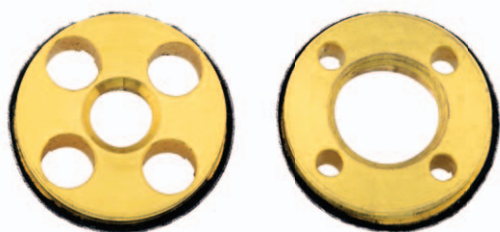

Comparison of the standard (left) and large (right) bore diameters for the available VSM coil sets.



Various sample holders for VSM measurements. The straw holder (top) and large brass trough are only compatible with the LBC, whereas the quartz paddle, small brass trough (with polycarbonate powder holders and quartz bracers shown), and heater stick (for VSM Oven measurements) can all be used with the standard bore coil set.

Large Bore Coil Set (VSM) Specifications

(for large bore in zero-field, unless indicated)

Magnetic Moment [m]

Accuracy:	$\pm 0.5\%$, using 2.8 mm dia. \times 4 mm tall cylinder (shape of included Pd reference)
Noise Floor*:	$< 1.5 \cdot 10^{-6}$ emu @ 300 K
Additional Relative Noise*:	$3.0 \cdot 10^{-7}$ emu/T or 0.5%, whichever is greater
Max Measurable Moment:	m_{max} [emu] = 75/Peak Amplitude [mm]

Drive Parameters

Oscillation Amplitude:	0.1 to 5 mm peak, 2 mm (typical)
Oscillation Frequency:	10 to 60 Hz, 40 Hz (typical)
Averaging Time :	0.5 to 750 seconds, 1 second (typical)

Coil Set Dimensions

Bore Diameter:	12 mm
Coil Separation:	12.2 mm

Operational Range

1.8 to 400 K; 0 to 16 T

*Parameters are integration-time dependent; stated values are for integration times of 1 second at 40 Hz, 2 mm amplitude excitation. Total observed noise is the sum of the floor and relative components.

Specifications are subject to change without notice.

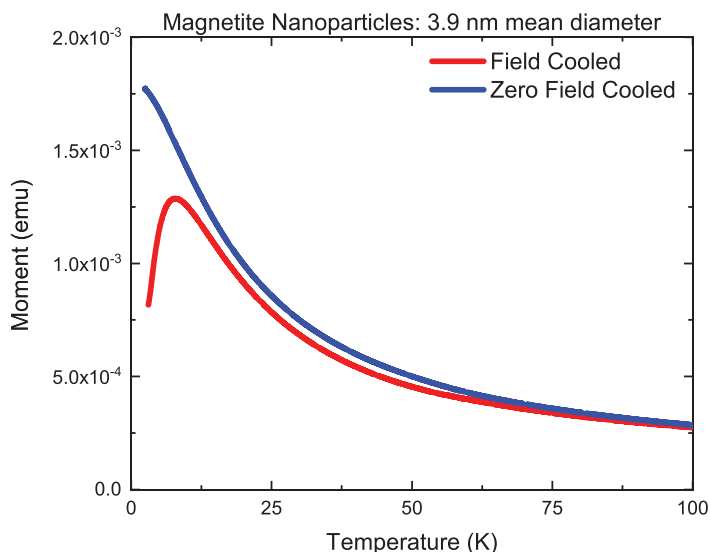

Field cooled (red) and zero field cooled (blue) curves measured in a 100 Oe field of a magnetite nanoparticle dispersion (3.9 nm mean diameter) exhibiting a blocking temperature of approximately 7 K. Sample provided by V. A. Ortiz-Vergara, M. A. Garza-Navarro, V. A. González-González Universidad Autónoma de Nuevo León, Facultad de Ingeniería Mecánica y Eléctrica.

Magnetometry

Vibrating Sample Magnetometer Oven

DynaCool (D527) / PPMS (P527) / VersaLab (V531)

The VSM Oven option allows the temperature range of the conventional VSM option to be extended upwards to 1000 K. This option employs the standard VSM coilset and transport motor but uses a special alumina sample holder with an integrated resistive heater and temperature sensor to locally heat and sense the sample temperature. A special sample rod and a hermetically sealed wired-access-port (WAP) provide electrical access to the oven sample holder. The nearby VSM coil set is protected by shielding the sample in a copper foil and operating in a high-vacuum environment (hi-vac capabilities are a prerequisite for the VSM oven).

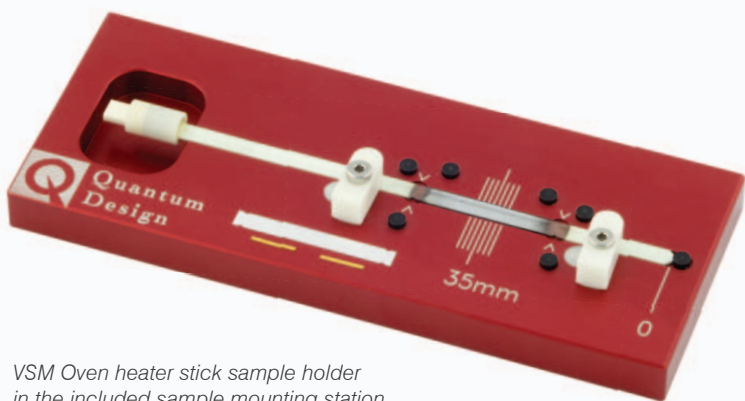

VSM Oven heater stick sample holder in the included sample mounting station (depicted discoloration is typical). Also shown are components of the optional P540 Dry Mount Kit, allowing samples to be secured without the use of the standard cement.

Key Features:

- User kit comes standard with sample mounting high temperature Zircar cement and copper radiation shields
- Pre-mounted high purity (99.994%) nickel reference sample ($T_C=627$ K) allows for quick verification of oven performance
- Optional dry-mounting kit allows for easy mounting of samples (e.g. thin films on substrates) without the need of cement

VSM Oven Specifications (for zero-field, unless indicated)

Temperature [T]

Range*:	300 to 1000 K
Ramp Rate:	Up to 1000 K/min.
Accuracy:	$\pm 2\%$ after stabilizing
Stability:	± 1 K, for fields up to 14 T

Magnetic Moment [m]

Accuracy**:	$\pm 2\%$ or $6 \cdot 10^{-6}$ emu, whichever is greater
Noise Floor***:	$< 6.0 \cdot 10^{-6}$ emu @ 300 K
Additional Relative Noise***:	$5 \cdot 10^{-7}$ emu/T or 0.5%, whichever is greater

Operational Range	300 to 1000 K; 0 to 16 T
--------------------------	--------------------------

*Please note, heater stick sample holders **cannot** be cooled below 300 K. The material becomes very brittle at colder temperatures and will likely fail.

**The background signal from the heater stick sample holder is not necessarily reproducible from holder to holder, which in turn will reduce accuracy.

***Parameters are integration-time dependent; stated values are for integration times of 1 second at 40 Hz, 2mm amplitude excitation. Total observed noise is the sum of the floor and relative components.

Specifications are subject to change without notice.

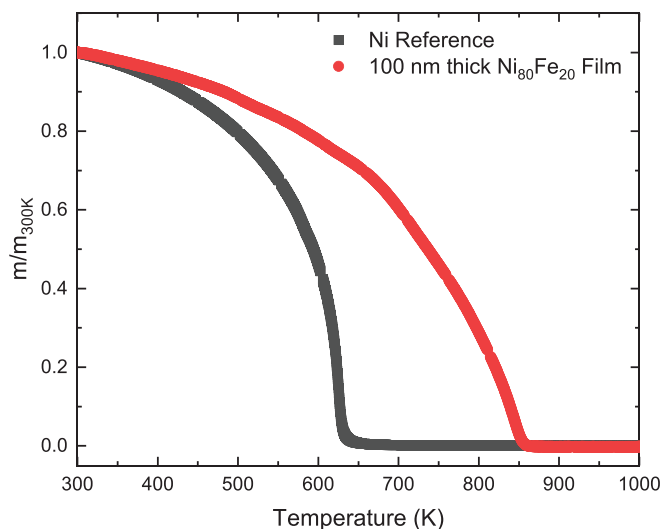

Normalized moment as a function of temperature for the included Ni reference (black) and a 100 nm thick Permalloy thin film (red) exhibiting the Curie temperature of each.

Magnetometry

First Order Reversal Curve (FORC) Software for VSM

DynaCool (D181) / PPMS (P181) / VersaLab (V181)

First Order Reversal Curve (FORC) measurements and their subsequent analysis provide additional insights into the magnetic reversal mechanisms of bulk, thin film, and nano-patterned samples that conventional major hysteresis loops cannot. These families of curves can provide a qualitative/quantitative fingerprint of various magnetic reversal mechanisms, as well as aid in distinguishing between reversible and irreversible switching mechanisms. Further applications of the technique include the ability to calculate reversal mechanism phase fractions along with coercivity and interaction field distributions.

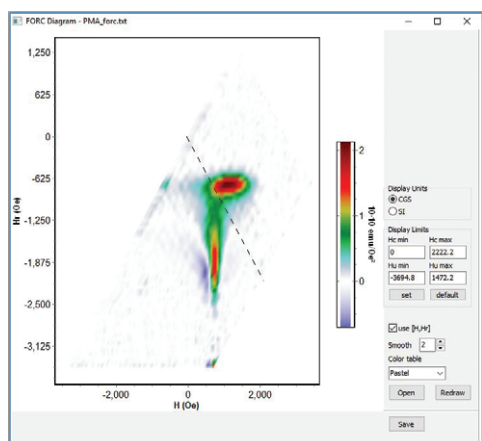

The FORC distribution of a $[\text{Co}(0.5 \text{ nm})/\text{Pd}(1 \text{ nm})]_{10}$ film exhibiting perpendicular magnetic anisotropy is plotted in the (H_c, H_u) coordinate system. Sample provided by Prof. Kai Liu, Georgetown University.

VSM FORC Specifications

See VSM Standard / Large Bore / Oven Specifications for Details

Operational Range 1.8 to 1000 K; 0 to 16 T

Specifications are subject to change without notice.

Key Features:

- Fully automated FORC acquisition using MultiVu
- FORC distributions can be calculated and displayed in real-time during a measurement
- Users can change between the (H_c, H_u) and (H, H_i) coordinate systems as well as update the smoothing factor, color scheme, and measurement units on the fly
- Compatible with any Quantum Design VSM configuration including the standard and large bore coil sets and the VSM oven
- Resulting output data file is preformatted for easy import into the FORCinel post-processing software

MultiVu User Interface

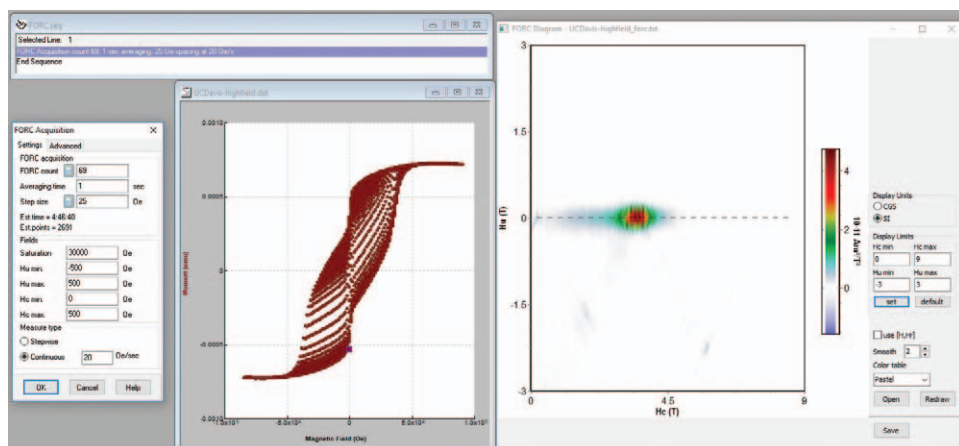

FORC measurements can be easily incorporated into standard VSM sequences. The FORC distribution of a high anisotropy FePt thin film is plotted in the (H_c, H_u) coordinate system. Sample provided by Prof. Kai Liu, Georgetown University.

Magnetometry

Fiber Optic Sample Holder (VSM)

DynaCool (D320) / PPMS (P320)

For samples exhibiting an evolution of their properties when subject to electromagnetic radiation, the VSM Fiber Optic Sample Holder (FOSH) enables light to be delivered to the VSM sample space during a measurement. A special sample holder, optimized either for the UV or IR ends of the spectrum, couples to a fiber optic carrying sample rod of the same material; on the other end a standard SMA-style feedthrough to the Wired Access Port can be connected to various light sources to provide the desired wavelength of radiation.

Key Features:

- Enables VSM measurements in the presence of electromagnetic radiation
- Specialized sample rod and holder transmitting a wide spectrum and optimized to further include either UV or IR
- Standardized fiber connection ensures compatibility with a wide range of light sources

FOSH Specifications (VSM) (for zero-field)

Magnetic Moment [m]

Sensitivity: $< 1 \cdot 10^{-4}$ emu

Sample Space Parameters

Maximum Length: 1.6 mm

Maximum Diameter: 1.6 mm

Transmittance: $> 60\%$ of 325 nm to 900 nm; UV holder
 $> 60\%$ of 375 nm to 2250 nm; IR holder

Sample Space Parameters 1.8 to 400 K; 0 to 9 T

Specifications are subject to change without notice.

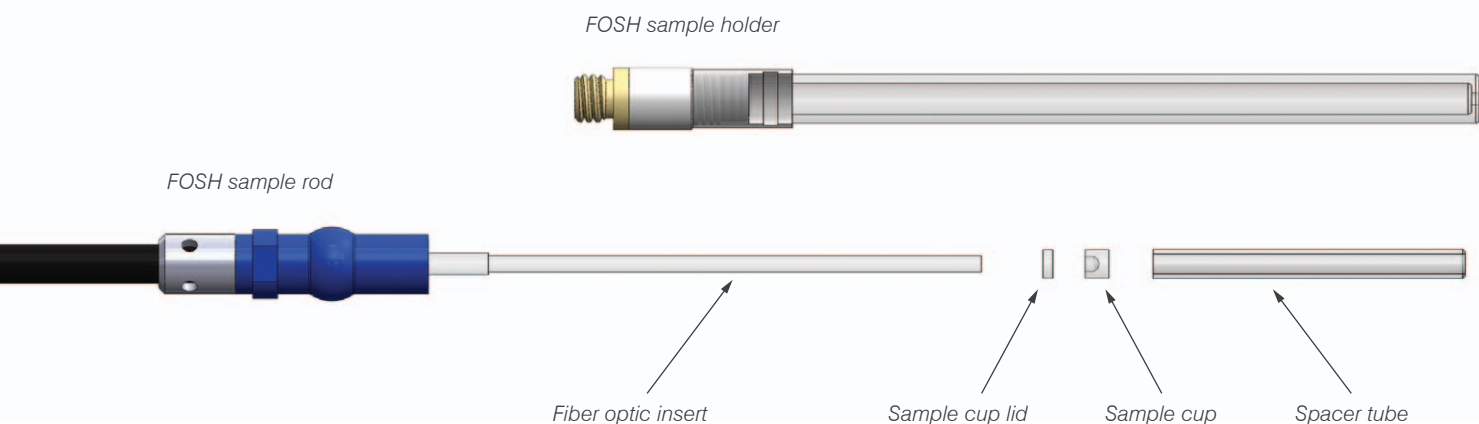

The optional TLS120Xe light source can be used to deliver light to a sample installed in the FOSH. (See page 29 for further details)



Magnetometry

High Pressure Cell for Magnetometry

DynaCool (D421) / PPMS (P421) / VersaLab (V421)

Often a sample's magnetic properties evolve under the application of substantial hydrostatic pressure. The pressure cell option for magnetometry is manufactured by HMD, a leading Japanese supplier of pressure cells. A simplified design requires neither copper sealing rings or a hydraulic press to achieve the maximum available pressure of 1.3 GPa, while its BeCu construction affords a minimized, uniform magnetic background.

Key Features:

- Complete kit includes required tools and materials for mounting samples, applying pressure to the cell, and measuring pressure
- Included manometer materials are tin and lead whose superconducting transition temperatures can be used to infer actual cell pressure
- BeCu construction provides minimal background signal and is also compatible with AC susceptibility measurements at suitably low frequencies



High Pressure Cell



Pressure Cell Kit

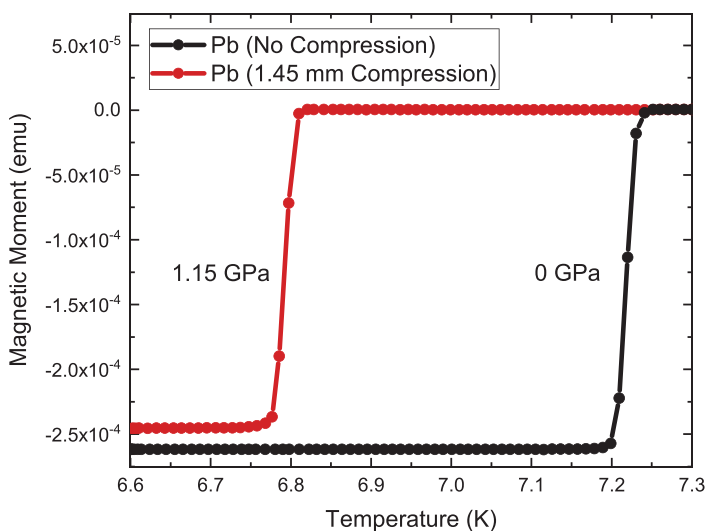

Temperature-dependent magnetization ($H = 2$ Oe) of elemental lead (Pb) depicting the suppression of the superconducting transition with applied pressure. For a given compression length of the cell the transition temperature can be measured and the pressure calculated using an equation of state.

High Pressure Cell (Magnetometry) Specifications

Pressure [P]	
Maximum Sample Pressure:	1.3 GPa
Sample Space Parameters	
Diameter:	1.7 mm, 2.2 mm
Length:	7 mm
Magnetic Moment [m]	
Background Signal:	$4 \cdot 10^{-7}$ emu/T
Operational Range	1.8 to 400 K; 0 to 9 T

Specifications are subject to change without notice.

Magnetometry

Torque Magnetometer (Tq-Mag)

DynaCool (D550) / PPMS (P550) / VersaLab (V550)

The torque magnetometer (Tq-Mag) measures the torque ($\tau = \mathbf{m} \times \mathbf{B}$) exerted on a magnetic sample with moment, \mathbf{m} , by an applied field, \mathbf{B} . By definition, a torque is only present if a component of \mathbf{m} is orthogonal to \mathbf{B} . Therefore, torque magnetometry is a powerful tool in the study of small anisotropic single crystals and thin films. The torsion is measured using piezoresistive elements on a calibrated cantilever chip as a function of magnetic field, temperature, or angular orientation. The automated calibration procedure substantially minimizes offsets from gravity and temperature to the measured torque.

Key Features

- Piezoresistive elements comprising a Wheatstone bridge are fabricated directly on the cantilever chip
- Integrated calibration loop on the cantilever chip
- Sample mounting entails only a small amount of vacuum grease to hold the sample to the cantilever with no additional wiring required
- Two chip variants are available:
 - (i) High-sensitivity chip for low noise ($1 \cdot 10^{-9}$ N·m)
 - (ii) Large-moment chip which extends the upper range of the measurement to $1 \cdot 10^{-4}$ N·m

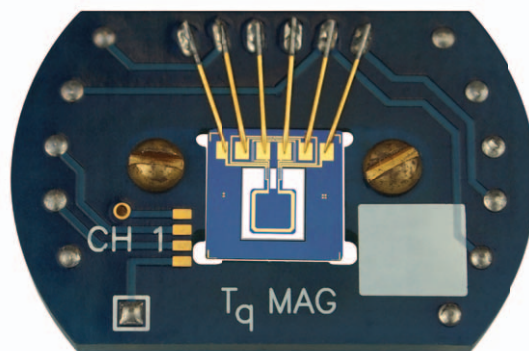

Tq-Mag chip

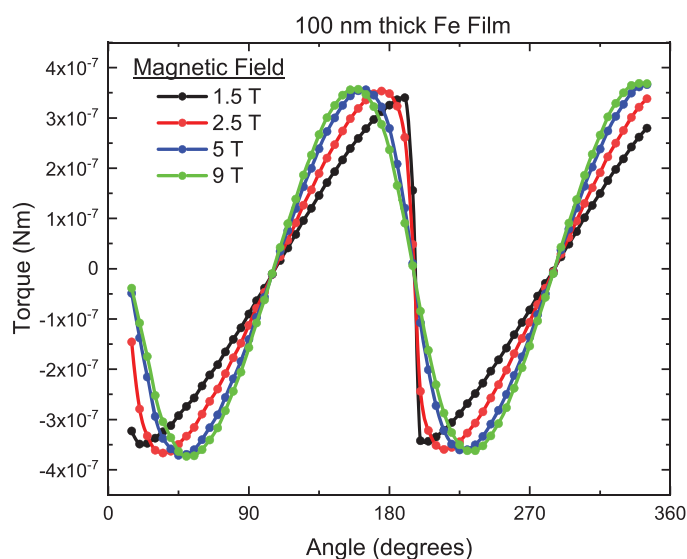
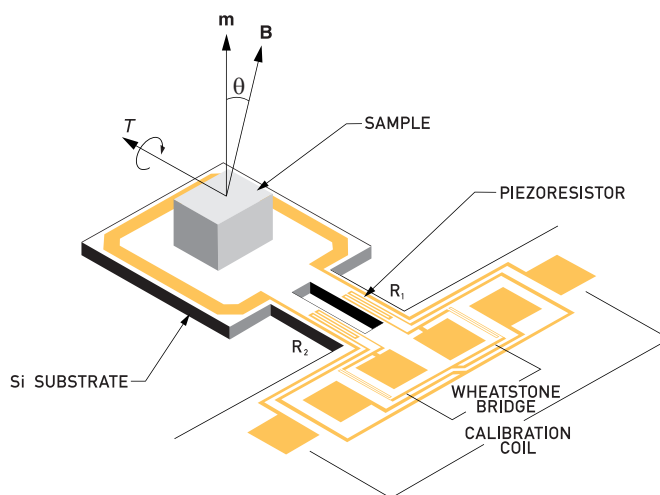

Torque curves measured at room temperature of a 100 nm thick Fe film as a function of the angle of the applied field (with respect to the film normal). At high fields the curves reflect the uniaxial anisotropy of the sample.

Torque Magnetometer Specifications

Torque [τ]

Noise Floor:	$1 \cdot 10^{-9}$ N·m (high sensitivity chip) $2 \cdot 10^{-8}$ N·m (large moment chip)
Maximum Torque:	$1 \cdot 10^{-5}$ N·m (high sensitivity chip) $1 \cdot 10^{-4}$ N·m (large moment chip)

Physical Parameters

Chip Size:	6 mm × 6 mm × 1 mm
Available Sample Volume:	1.5 mm × 1.5 mm × 1.5 mm
Maximum Sample Weight:	10 mg

Operational Range 1.8 to 400 K; 0 to 16 T

*Stated value is for a 40 second sampling time
Specifications are subject to change without notice.

Magnetometry

AC Susceptibility (ACMS II)

DynaCool (D505) / PPMS (P505) / VersaLab (V505)

The AC Measurement System (ACMS II) is a versatile susceptometer for magnetic measurements. In addition to a mutual induction-based determination of the AC susceptibility, the ACMS II enables the user to perform DC magnetization measurements without having to change sample mounts, electronics, or the hardware configuration. The coil set assembly can be used over the entire field and temperature range of the base system.

Key Features:

- Automated nulling procedure utilizes trim coils to minimize background contributions to the measured AC susceptibility
- Multi-point background subtraction schemes available to improve AC susceptibility accuracy
- Susceptibility can be parameterized either as a total moment and phase angle $[\chi, \theta]$ or as a real and imaginary component $[\chi', \chi'']$
- Automated touch-down procedure preserves sample centering across large changes in temperature
- Included sample holders allow for various types of samples to be measured including: small single crystals, thin films (can be oriented with applied field in- or out-of film plane), sintered polycrystalline pieces, and loose powders
- Capability to record higher harmonic data is available with an optional upgrade (P505H)

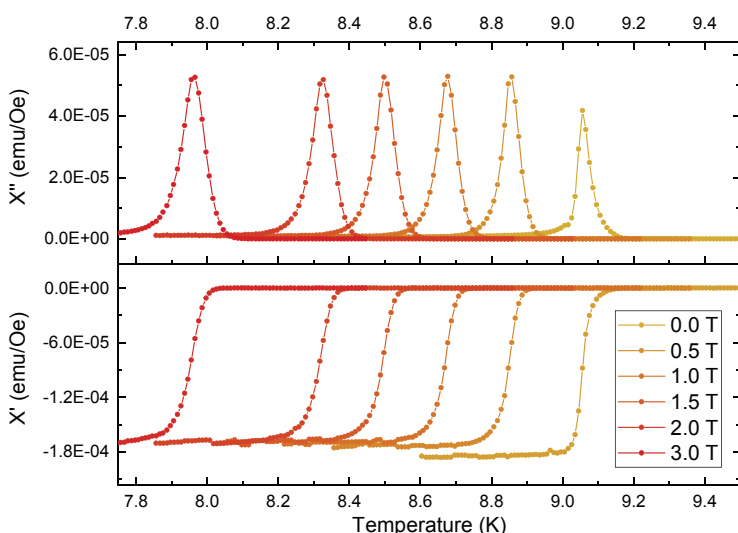

Temperature dependence curves of the real and imaginary components of AC susceptibility in a NbTi sample for a family of fixed magnetic fields. The onset of temperature of the superconducting state is suppressed lower for increasingly high field strengths.

AC Measurement System (ACMS II) Specifications

(for zero-field)

AC Susceptibility $[\chi]$

Sensitivity*: $1 \cdot 10^{-8}$ emu @ 10 kHz
Phase Accuracy: $\pm 0.5^\circ$

DC Magnetic Moment $[m]$

Sensitivity: $5 \cdot 10^{-6}$ emu
Accuracy: $\pm 1\%$

Drive Parameters

Amplitude: 0.05 to 15 Oe (peak)
Frequency Range: 10 Hz to 10 kHz

Coil Set Dimensions

Bore Diameter: 8 mm

Operational Range

1.8 to 400 K; 0 to 16 T

*Expect an order of magnitude decrease in sensitivity for every order of magnitude decrease in drive frequency.

Specifications are subject to change without notice.

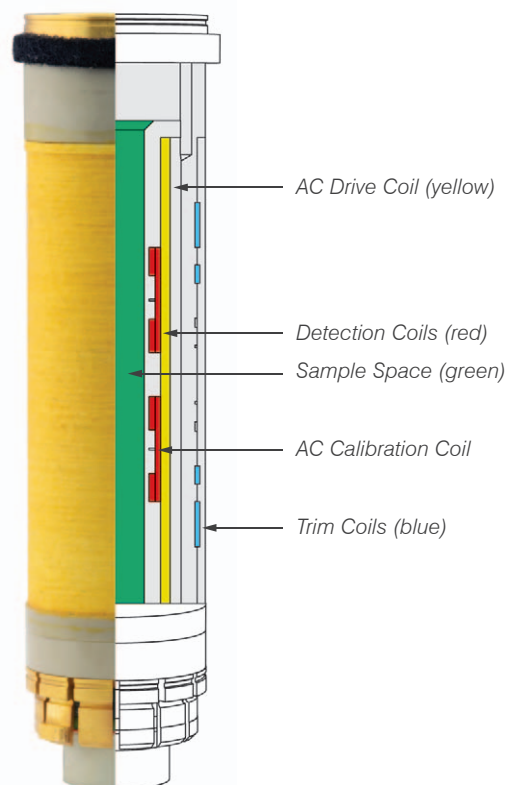

Schematic view of the ACMS-II coil set internal components showing the various individual constituent coils.

Thermal Measurements

Thermal Transport (TTO)

DynaCool (D670) / PPMS (P670) / VersaLab (V670)

Using the Thermal Transport Option (TTO) all three constituent experimental parameters of the thermoelectric figure of merit (ZT) can be measured simultaneously and continuously as a function of temperature. Operating in high vacuum, a sample is subjected to a thermal pulse and its temperature and voltage responses are recorded. Fitting algorithms based on a model of the thermal circuit extract a sample's thermal conductance and thermopower from these curves, and a resistance measurement is executed immediately after. ZT is automatically calculated as well, and can be evaluated across the full range of temperature and field afforded by the PPMS.

Key Features

- Simultaneously measure a sample's thermal conductivity, Seebeck coefficient, and electrical resistivity with a single sequence command
- Derived thermoelectric figure of merit and associated uncertainty is automatically calculated
- Mounting hardware included for two- or four-probe configuration to best suit a particular sample's geometry
- Adaptive measurement algorithm enables continuous data acquisition while ramping temperature, eliminating the need to repeatedly wait for stability as in traditional conductance measurements
- Raw data can be viewed for real-time diagnostics of data quality or post-processing using custom fit functions
- User kit includes specialized mounting hardware, lead material, conductive epoxy, and an extra set of heater/thermometers



TTO Puck with Disk-Shaped Sample Installed



Thermal Transport Option Puck installed in the Puck Mounting Station

Thermal Measurements

Thermal Transport (TTO)

DynaCool (D670) / PPMS (P670) / VersaLab (V670)

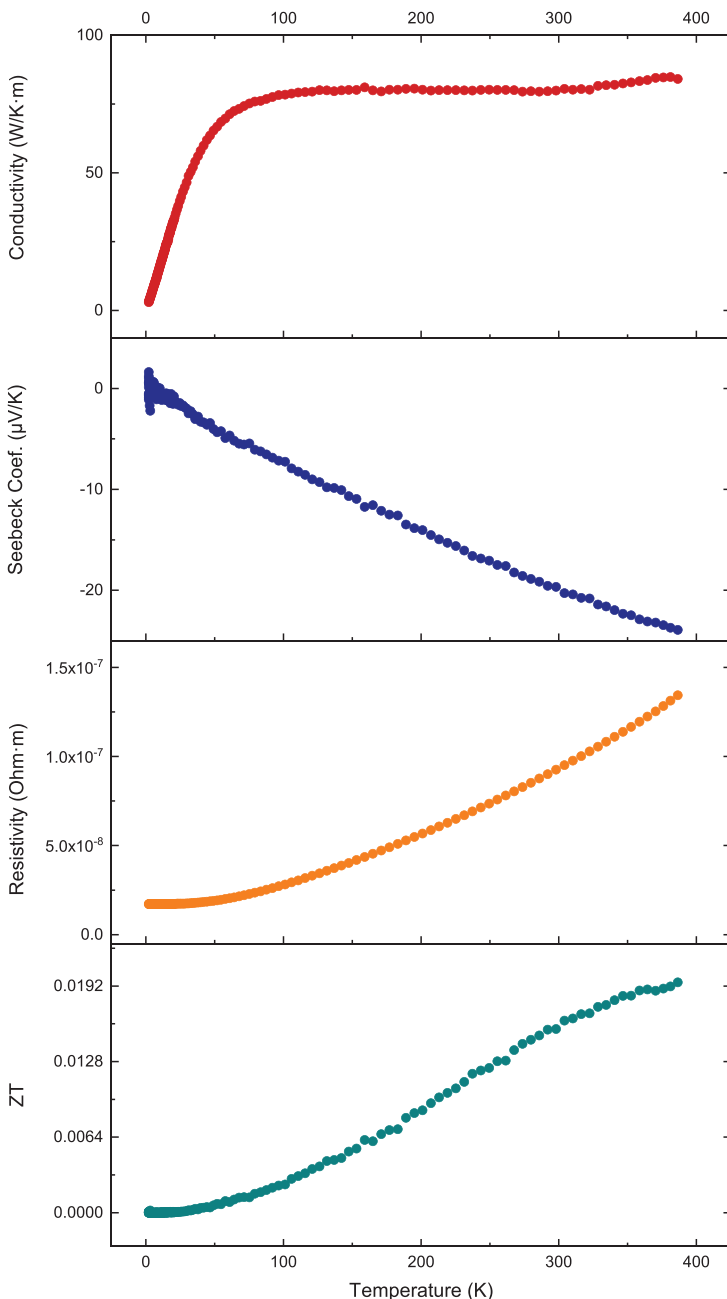

A typical response of the three properties measured by the TTO (thermal conductivity, Seebeck coefficient, electrical resistivity) are all shown, along with the calculated thermoelectric figure of merit ZT, for the nickel reference sample included with the option.

Thermal Transport (TTO) Specifications (for zero-field)

Thermal Conductance [K]

Typical Accuracy:

± 5 % or ± 2 μW/K, whichever is greater, for T < 15 K
 ± 5 % or ± 20 μW/K, whichever is greater, for 15 K < T < 200 K
 ± 5 % or ± 0.5 mW/K, whichever is greater, for 200 K < T < 300 K
 ± 5 % or ± 1 mW/K, whichever is greater, for T > 300 K

Estimated Dynamic Range*:

1 to 25 mW/K for high T = 400 K
 100 μW/K to 100 mW/K for T ≈ 50 K
 10 μW/K to 1 mW/K for T ≈ 1.9 K

Thermal Conductivity

$$[\kappa = K \cdot (L/A)]$$

Estimated Dynamic Range*:

0.1 to 250 W/m·K @ T = 300 K

Seebeck Coefficient [S]

Typical Accuracy:

Error in S = ± 5 % or,
 Error in S = ± 0.5 μV/K or,
 Error in V = ± 2 μV,
 whichever is greatest

Estimated Dynamic Range*:

1 μV/K to 1 V/K

Resistivity [$\rho = R \cdot (A/L)$]

Typical Precision:

0.01% for 1 Ω @ 200 μA

Estimated Dynamic Range*:

10 μΩ to 5 MΩ

Thermoelectric Figure of Merit [ZT = T·S²/(κ·ρ)]

Typical Accuracy:

± 15 %
 (Assumes ± 5% accuracy of K and S and negligible contributions from T, ρ)

Speed of Acquisition

Typical Temperature Slew Rates:

± 0.5 K/min, T > 20 K
 ± 0.2 K/min, T < 20 K

Operational Range

1.8 to 400 K; 0 to 16 T**

*Range estimates can depend significantly on an individual sample's aspect ratio and heat capacity.

**Measuring under both applied magnetic fields greater than H = 0.1 T and temperatures below T = 20 K may require additional corrections due to the temperature sensors' intrinsic magnetoresistance.

Specifications subject to change without notice.

Thermal Measurements

Heat Capacity

DynaCool (D650) / PPMS (P650) / VersaLab (V650)

The Heat Capacity Option leverages a puck-based microcalorimeter design capable of measuring sample heat capacity across the full range of temperature and field afforded by the PPMS. Operating in high vacuum, a sample is subjected to a thermal pulse and its temperature response is recorded as in a traditional semi-adiabatic relaxation technique. Fitting algorithms based on a model of the thermal circuit extract sample heat capacity from this curve. Typical measurements collect heat capacity as a function of temperature; measurements under a constant field are possible after using the automated field calibration function of the software.

Key Features:

- Software-automated addenda (background) signal collection and subtraction
- Advanced fitting algorithms measure and account for finite thermal conduction between the calorimeter and sample for improved measurement accuracy
- Measurement heat pulse duration is determined by the sample time constant τ , dynamically adapting to changes in sample heat capacity as it evolves with temperature
- Unique mounting station hardware ensures hassle-free sample mounting and minimizes the risk of damage to delicate calorimeter wiring
- Alternate slope-fitting analysis mode available in post processing for high resolution sampling of sharp first-order transitions
- Units system can be user-specified to report intrinsic properties like specific heat capacity

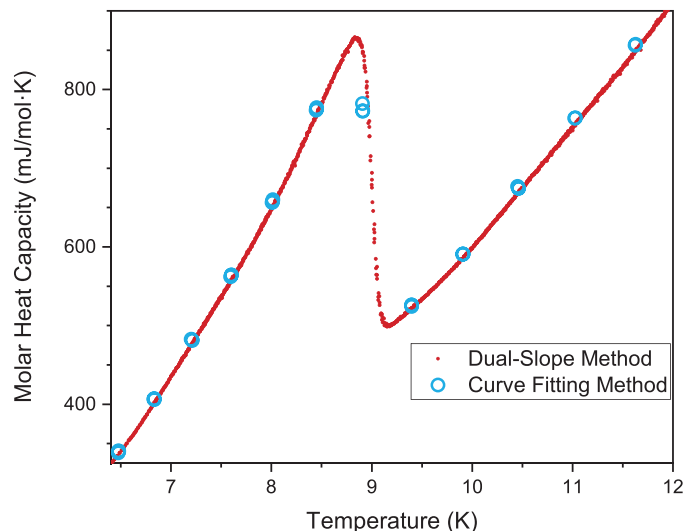

A superconducting transition is shown for a sample of NbTi alloy near 9 K. The open blue circles indicate data collected using the default curve fitting technique on a number of small heat pulses while the smaller closed red points were acquired using the slope-fitting analysis of a single large heat pulse.



Heat Capacity Puck installed in the Sample Mounting Station

Optional Vertical Puck Kit (P111), shown with Heat Capacity Frame



Heat Capacity Specifications (for Zero Field)

Heat Capacity [C_p]

Accuracy: $\pm 5\%$ for 2 K to 300 K; $\pm <2\%$ typical
Resolution: 10 nJ/K @ 2 K

Addenda Characteristics

Calorimeter Platform Area
(maximum sample footprint): 3 mm \times 3 mm
Typical Addenda Magnitude: 0.2 μ J/K @ 2 K; 15 mJ/K @ 400 K

Operational Range 1.8 to 400 K; 0 to 16 T

Specifications are subject to change without notice.

Thermal Measurements

Dilatometer

DynaCool (D680) / PPMS (P680)

For quantifying a sample's thermal expansion coefficient or probing magnetostriction effects, the Dilatometer offers unparalleled resolution and convenience. The dilation is determined by rigidly coupling a sample's expansion/contraction to the distance between the plates of a capacitor. Further, a ratiometric voltage measurement renders a large costly absolute capacitance bridge unnecessary, while the fused-silica cell design requires no first-order corrections due to adsorbed gas, thermal gradients, or applied magnetic field.

Key Features

- Lapping tools for sizing samples to the ideal width (2 mm) included along with measurement electronics, probe, and cell hardware
- Provided balance meter allows users to confirm proper sample sizing by a direct measurement before hardware is installed in the PPMS
- Manual rotation (rotation axis normal to the direction of applied field) of the sample within the cell between -20° and $+110^\circ$ outside of the PPMS enables systematic anisotropy studies
- Fused silica and copper reference samples included for periodic verification of system performance

Dilatometer Specifications (for zero-field)

Dilation [ΔL]

Resolution:	< 10 pm, @ 2 K
Noise Floor:	< 20 pm, @ 2 K
$\Delta L/L$ Resolution:	10^{-9} , for 2 mm wide sample
Background Dilation:	< 75 nm (300 \rightarrow 2 K) < 10 pm (0 \rightarrow 9 T)

Sample Space Parameters

Ideal Sample Size*:	2 ± 0.05 mm \times 2.5 mm \times 3 mm
---------------------	---

Operational Range

1.8 to 400 K; 0 to 16 T

*For samples narrower than 2 mm, included shims can be used; other dimensions are not tightly constrained.

Specifications are subject to change without notice.



Dilatometer Capsule installed in the Balance Meter

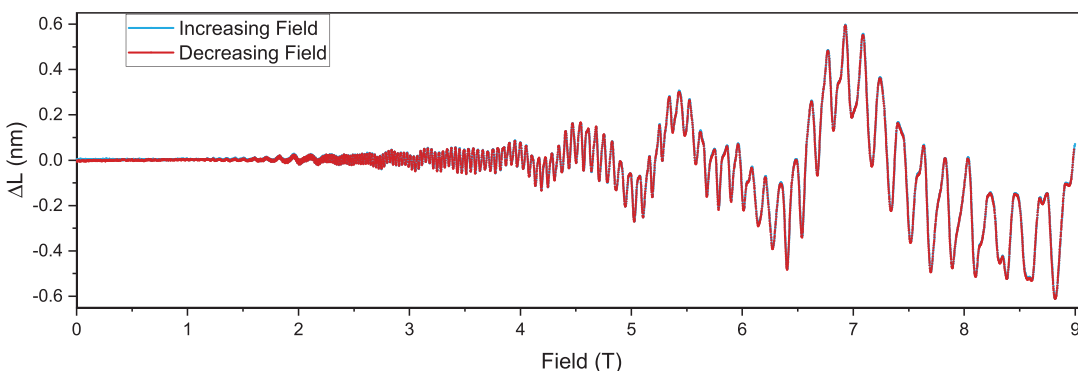

The change in length of a 2 mm long aluminum piece at 2 K is shown as a function of applied magnetic field; oscillations in dilation due to the de Haas-van Alphen effect can clearly be seen. The blue curve reflects data taken upon increasing the applied field, while the red curve corresponds to the subsequent decreasing of the field. In the 12 hours it took to collect the data, the total drift was on the order of only 10 pm (hence the red curve largely obscuring the blue).



Dilatometer Capsule with copper sample

Sub-Kelvin Capabilities

Adiabatic Demagnetization Refrigerator (ADR)

DynaCool (D810) / PPMS (P810)

For basic transport experiments not requiring applied magnetic field, the base temperature of the PPMS can easily be extended as low as to 100 mK using the Adiabatic Demagnetization Refrigerator (ADR). This option includes a specialized puck which integrates a sealed capsule of paramagnetic salts. After the puck is cooled to the base temperature of the PPMS (1.9 K) a magnetic field (3 T) is applied and the system pumped to a high-vacuum state. Quickly turning the field off allows the magnetic entropy of the salt to increase, which in turn rapidly cools the sample platform to 100 mK. Measurements can then be collected as the temperature slowly rises back to the PPMS base, where temperature control is regained and standard operation can resume.

Key Features:

- Extends zero-field transport measurements (ETO/Resistivity) down to 100 mK
- Allows for more than 2 hours of measurement time below typical PPMS base temperature
- Two 4-probe channels available for increased sample throughput
- Permanently sealed chamber of paramagnetic salts does not require replacing for the lifetime of the option

ADR Specifications

Accessible Temperatures

Range: 150 mK to 300 K
(100 mK base typical)

Accessible Temperatures

Time to ADR Base Temperature from 300 K: 3 hours
Time from 0.1 to 1.9 K (Uncontrolled Drift): 2 hours (typical)

Operational Range

0.1 to 300 K; 0 T

Specifications are subject to change without notice.



Included user kit for the ADR with additional transport pucks and a USB drive with archived thermometry calibration files.

ADR with transport puck installed

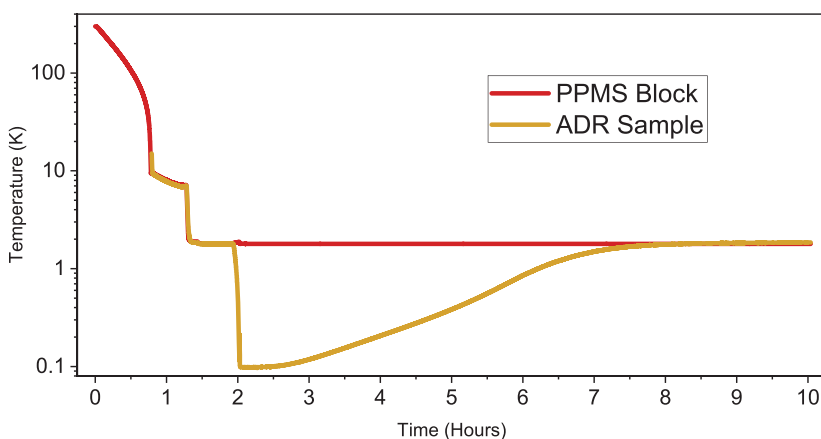

Example log of an ADR cooldown, starting from room temperature. In this case, base temperature is reached in just over two hours and the uncontrolled drift back to the PPMS block temperature lasts roughly six hours.

Sub-Kelvin Capabilities

Helium-3 Refrigerator

DynaCool (D825A/V) / PPMS (P825A/V)

The Helium-3 refrigerator insert reduces the ultimate base temperature achievable in the PPMS to 0.4 K so a full four decades in temperature are accessible for compatible measurements. Software-automated gas handling of a variety of specialized cooling modes enables fast and responsive control across the available temperature range with no need for any additional user intervention. Continuous operation is possible down to 0.5 K with optional 'one-shot' operation to achieve temperatures as low as 0.35 K.

Key Features

- Software user interface for temperature control is identical to that of the base PPMS, as are sequence commands – all gas handling operations are fully automated
- Closed-cycle gas handling loop pre-filled with ^3He gas
- Automated maintenance wizards for storing and cleaning cooling mixture to maintain system performance
- Vertical (825V) and horizontal (825A) sample mount configurations available
- Compatible measurement options: AC/DC electrical transport, heat capacity

Helium-3 Refrigerator probe mounted in the integrated gas-handling cart



Helium-3 Refrigerator is available either with a horizontal sample stage (left) or a vertical sample stage (right)

Helium-3 Refrigerator Specifications

Temperature Control

Range*:	< 0.4 K (0.35 K typical) to 350 K
Accuracy**:	$\pm 1\%$
Stability:	$\pm 0.2\%$

Operational Capabilities

Cooling Power:	6 μW at sample stage at 0.5 K 80 μW at sample stage at 1.0 K
Cool Down Time (300 to 0.5 K):	Less than 3 hours; 2 hours typical

Operational Range

0.4 to 350 K; 0 to 16 T

*Indefinite continuous operation limited to a base of 0.5 K; temperatures below 0.4 K achievable for up to 60 minutes at a time using 'one-shot' mode.

**Quoted up to the maximum field of the PPMS.

Specifications are subject to change without notice.

Sub-Kelvin Capabilities

Dilution Refrigerator

DynaCool (D850) / PPMS (P850)*

***INCOMPATIBLE with PPMS installations using EverCool II option.**

The dilution refrigerator insert for the PPMS enables access to a temperature range spanning 4 K all the way down to 50 mK for a number of compatible measurement options and custom user experiments. Software-automated gas handling of both evaporative and dilution cooling modes enables fast and responsive control across three decades of temperature and enables access to the lowest base temperature possible in a PPMS.

Key Features

- Software user interface for temperature control is identical to that of the base PPMS, as are sequence commands – all gas handling operations for dilution and evaporative cooling modes are fully automated
- Closed-cycle gas handling loop pre-filled with proper $^3\text{He}/^4\text{He}$ mixture ratio
- Automated maintenance wizards for storing and cleaning cooling mixture to maintain system performance
- Compatible measurement options: AC/DC electrical transport, heat capacity, AC susceptibility

Zero-field heat capacity data depicting the superconducting transition in $\text{Ir}_{0.8}\text{Ru}_{0.2}$ occurring near the base temperature of the Dilution Refrigerator. Sample provided by Milton S. Torikachvili of San Diego State University.

Dilution Refrigerator Specifications

Temperature Control

Range: 50 mK to 4 K
Accuracy*: $\pm 10\%$, for $T = 50$ mK
 $\pm 2\%$, for $T = 300$ mK
 $\pm 1\%$, for $T = 4$ mK
Stability: $\pm 0.2\%$ or better

Operational Capabilities

Cooling Power: $0.25 \mu\text{W}$ at sample stage at 100 mK
Cool Down Time (300 K to 50 mK): Less than 8 hours; 5 hours typical
Space for User Experiments: $0.88''$ (22 mm) diameter by $1.4''$ (35 mm) long cylindrical volume

Operational Range:

0.05 to 4 K; 0 to 16 T

*Quoted up to the maximum field of the PPMS.

Specifications are subject to change without notice.

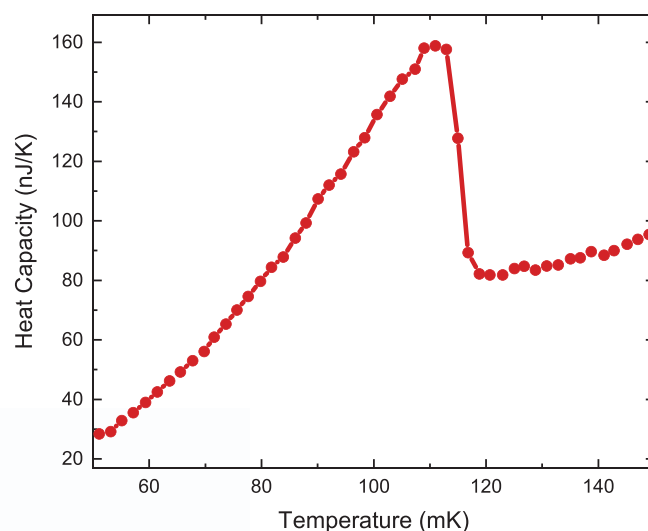

Dilution Refrigerator with Transport Puck

Sub-Kelvin Measurements

Several existing PPMS measurement options have been adapted to operate at sub-Kelvin temperatures in the various refrigerators offered. In some cases, additional hardware and/or electronics may be required for full compatibility, and the associated specifications are modified accordingly.

AC Resistance, DC Resistance [ADR, Helium-3, DR]

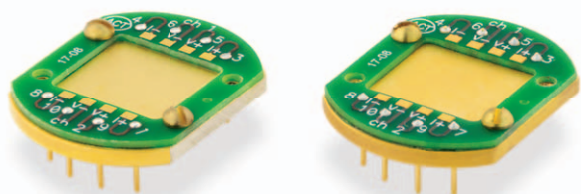

DR (left) and Helium-3 (right) Transport Pucks for use with either Resistivity or ETO

Sub-Kelvin Measurements Specifications (for Zero Field)

AC Resistance, DC Resistance [ADR, Helium-3, DR]

Identical to standard specifications except:

Current Amplitude Range: Maximum available current may be further limited by sample resistance and available cooling power, or desired drift rate in the case of the ADR.

Operational Range: 0.1 to 300 K; 0 T (ADR)
0.4 to 350 K; 0 to 16 T (³He)
0.05 to 4 K; 0 to 12 T (DR)

Heat Capacity [Helium-3, DR]

Identical to standard specifications except:

Typical Addenda Magnitude: 2.5 nJ/K @ 0.05 K, 225 nJ/K @ 2 K,
1.5 μ J/K @ 4 K; (DR)
10 nJ/K @ 0.4 K, 2.25 μ J/K @ 4 K,
340 μ J/K @ 35 K, 11 mJ/K @ 350 K; (³He)

Operational Range: 0.4 to 350 K; 0 to 16 T (³He)
0.05 to 4 K; 0 to 16 T (DR)

Specifications are subject to change without notice.

Heat Capacity [Helium-3, DR]



Dilution Refrigerator / Helium-3
2D Heat Capacity Puck

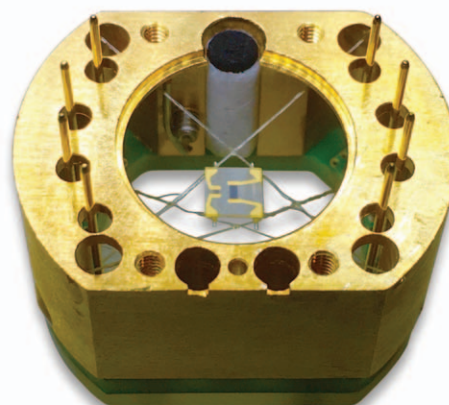

Dilution Refrigerator
3D Heat Capacity Puck
(DynaCool only)

Sub-Kelvin Measurements

AC Susceptibility [DR]

The AC Susceptibility Option for the Dilution Refrigerator (AC DR) brings the easy usability of the ACMS II option into the milli-Kelvin temperature range. Thermally anchoring the coil set to the puck interface rather than the DR sample stage, and using superconducting wires for the drive coils, lead to virtually no heat load on the DR. This allows for a mutual induction-based determination of the AC susceptibility of samples for frequencies between 10 Hz and 10 kHz down to 50 mK.

Sub-Kelvin Measurements Specifications (for Zero Field)

AC DR [DR]

AC Susceptibility [χ]

Sensitivity*: $5 \cdot 10^{-7}$ emu @ 10 kHz
Phase Accuracy: $\pm 2^\circ$

Drive Parameters

Drive Amplitude: 2 mOe to 4 Oe (peak)
Frequency Range: 10 Hz to 10 kHz
Operational Range: 0.05 to 4 K; 0 to 14 T

*Expect an order of magnitude decrease in sensitivity for every order of magnitude decrease in drive frequency.

Specifications are subject to change without notice.

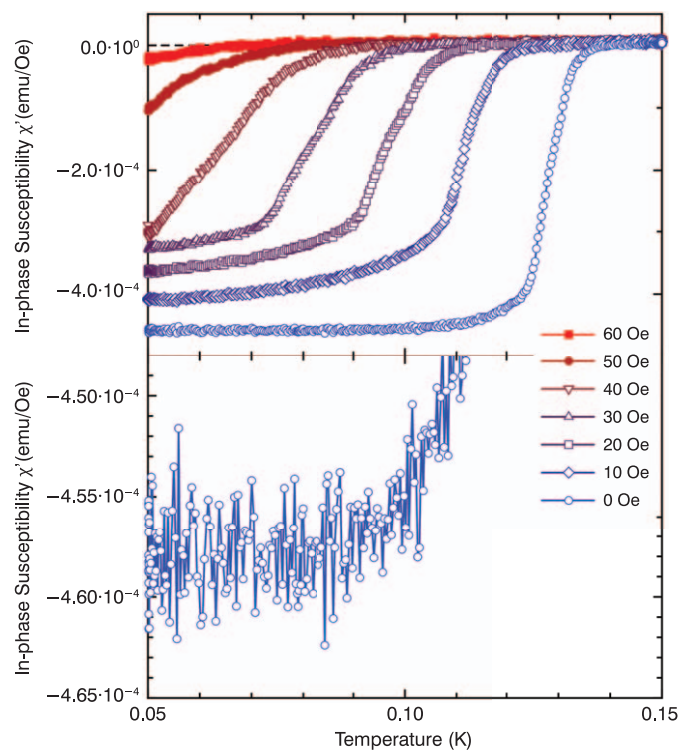

In-phase susceptibility for the superconducting transition of an $Ir_{0.8}Ru_{0.2}$ sample measured using an AC excitation of 10 mOe and a frequency of 10 kHz for various DC background fields. The lower graph highlights the noise level for the zero field data. The peak to peak scatter of the data is about 5×10^{-6} emu/Oe, corresponding to 5×10^{-8} emu in absolute signal.

Sample provided by Milton S. Torikachvili of San Diego State University.



DR Probe with AC DR Sapphire Sample Stage



AC DR Coil Set

Multi-Function Probes

Developed for users desiring to leverage the sample environment of a PPMS for their own custom experiments, the Multi-Function Probe (MFP) provides a compatible basic probe framework for further additions and specialization. All types allow access to the sample space by customizing the top-plate, include baffles to prevent heat from the room temperature top-plate from propagating to the isothermal region, and some variants enable connection to the 12-pin socket at the base of the sample chamber.

Relevant Application Notes

- ESD-sensitive probe (1070-212)
- Photoconductivity probe (1084-752)
- CryoFMR (1087-201)
- Microwave Resonator / EPR (1084-750)

Specifications

Operational Range: 1.8 to 400 K; 0 to 16 T
 CryoFMR Operational Range: 4 to 400 K; 0 to 16 T
 (as delivered before modification)

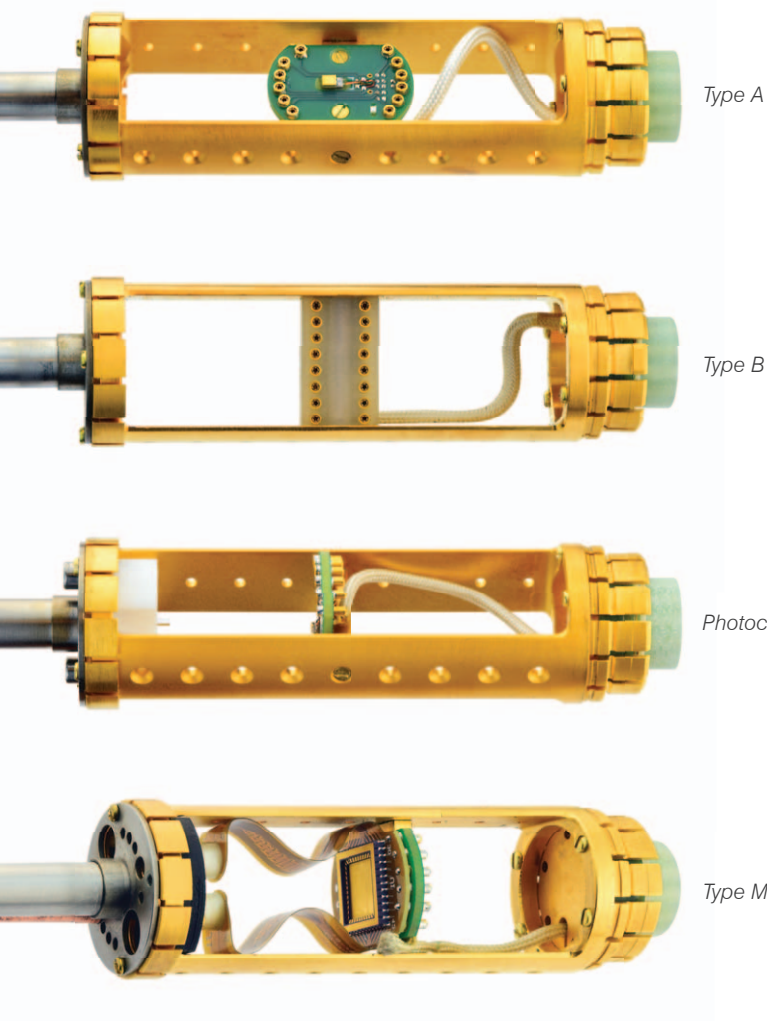

Available MFP Types

DynaCool (D450A/B/C/M) / PPMS (P450A/B/C/M)
 VersaLab (V450A/B/C/M):

- **“A” Type:** includes a wired socket already connected to the 12-pin puck interface which has integrated thermometry and accepts standard QD sample mounting boards. The socket can be placed at various heights in the bottom fixture and also can be manually rotated when the probe is out of the PPMS.
- **“B” Type:** includes a wired 16-pin DIP-type socket connected to the 12-pin puck interface.
- **“C” Type:** only includes the probe body with no transfer case at the bottom end.
- **“M” Type:** for use with a removeable chip carrier / flex-cable ribbon assembly; allows for up to 48 connections to be carried down into the sample space. Includes integrated thermometry.

DynaCool (D790) / PPMS (P790):

- **Photoconductivity Variant:** modified A-Type including one (or optionally, two) 1 mm core diameter optical fibers running down to the sample for sample illumination and/or spectroscopy.

DynaCool (D886A/B) / (P886A/B) / (V886A/B):

- **“CryoFMR” Variant:** heavily modified A-Type intended for spectroscopically probing a material's ferromagnetic resonance (FMR) response. Includes Helmholtz coils for low-frequency AC field modulation and cryo-coaxial cables for delivery and return of RF signals (886A supports up to 18 GHz RF signals, 886B supports up to 40 GHz). Specialized waveguides orient a thin-film sample perpendicular or parallel to the DC field. Compatible NanOsc spectrometer also available for a complete integrated measurement option.



Top plate construction is common to all MFPs (though some have additional modifications not pictured here).



Multi-Function Probes

Optical Multi-Function Probe (OMFP)

DynaCool (D725A/B) / PPMS (P725A/B) / VersaLab (V725A/B)

The Optical Multi-Function Probe (OMFP) offers unprecedented versatility in affording the user optical access to experiments within the variable temperature and magnetic field environment of the PPMS[®] family of instruments. At the top of the OMFP, a wired access port (WAP) features an axial optical port window for free-beam experiments in the cryostat. The WAP also features modular feedthrough connectors that can be configured to allow electrical signals or fiber access to the sample space. Adjustable optical mounts can be placed along the length of the probe to position filters, relay lenses, objectives, or other elements. The capsule at the bottom contains a three-axis piezo stack allowing the in-plane position to be adjusted, and for the sample to be moved into the proper focal plane. Integrated thermometry supplies temperature readings as close to the sample as possible for accurate mapping of temperature-dependent phenomena.

Key Features:

- Customizable 1" (SM1) free-beam access port and internal 1/2" (SM05) mounts along the optical path
- Modular feedthroughs available for electrical signals into the sample space
- Eight contacts (2 sets of 4) available on a removable PCB sample platform for electrical measurements using existing QD transport options or external electronics
- Optional variation (725B) includes eight additional electrical feedthroughs at the sample location, accessible externally via the WAP
- Optical camera allows for fine alignment and focus *in situ*
- XYZ piezo-positioning system enables multiple samples or regions of interest to be investigated
- Complete integration of imaging and positioning with MultiVu software sequence commands
- Includes a test station for *ex situ* alignment of optical elements and testing for proper electrical connections to the sample

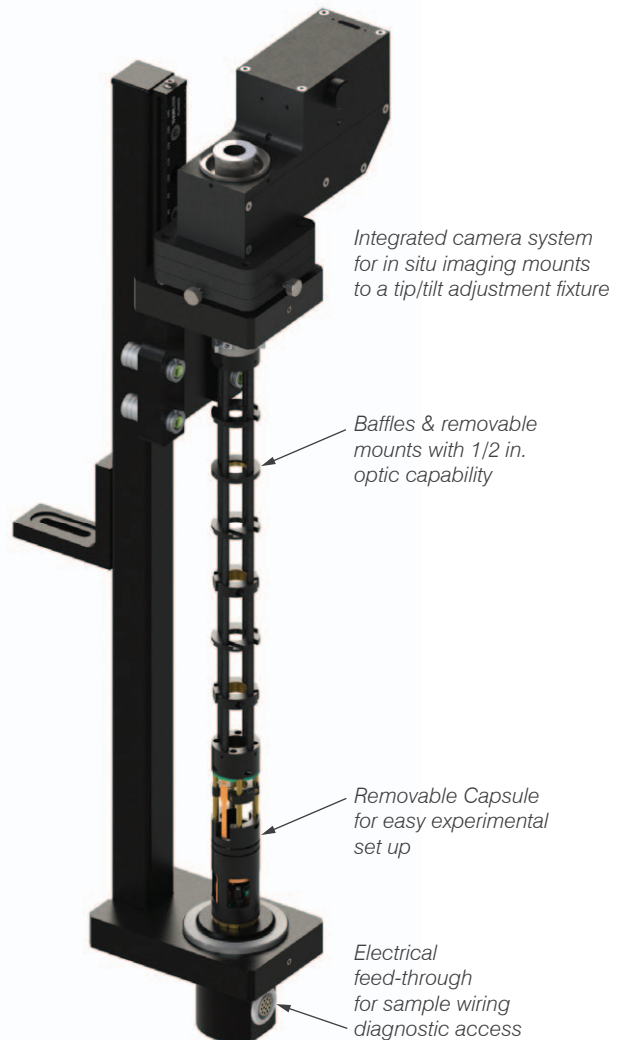

The external OMFP test station can be used to easily align optics *ex situ* and check for proper electrical connection to the sample.

XYZ Positioning Stage removed from the capsule housing. OMFP Positioner Capsule with sample boards and extraction tool.

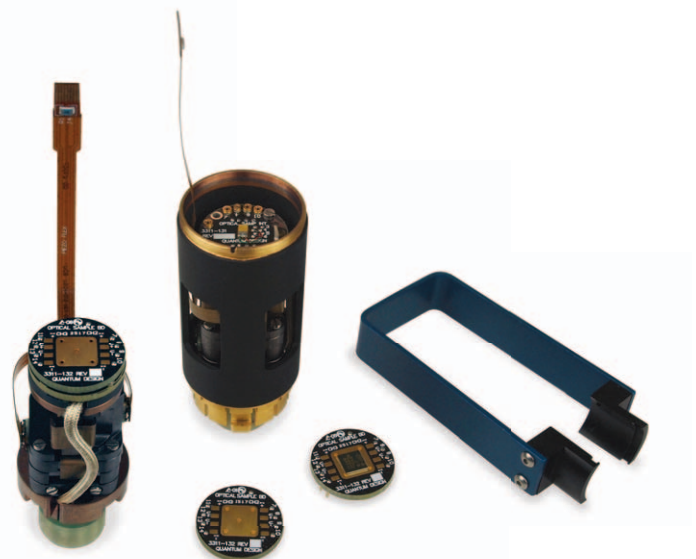

Multi-Function Probes

Optical Multi-Function Probe (OMFP)

DynaCool (D725A/B) / PPMS (P725A/B) / VersaLab (V725A/B)

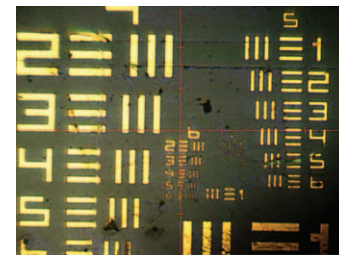
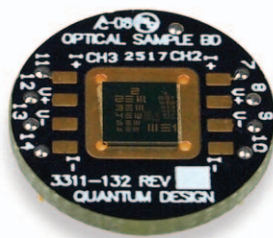

Included 1951 USAF resolution test chart sample is shown mounted on a sample board (left). Image of the target taken using the integrated image capture software demonstrating the approximate system resolution (right).

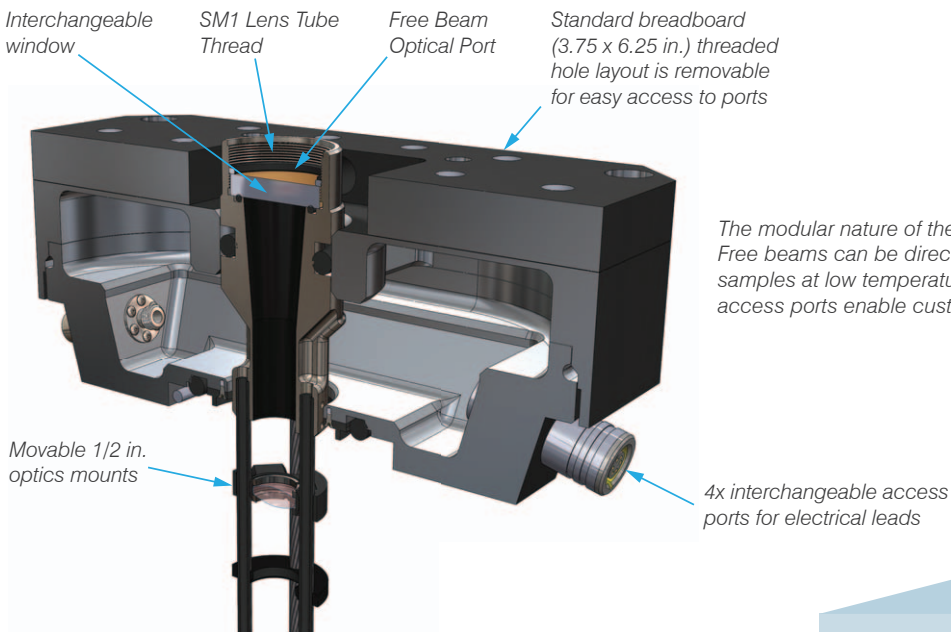

The modular nature of the OMFP allows for creative experimental design. Free beams can be directed through a variety of optical components to samples at low temperatures and high fields, while the interchangeable access ports enable customized applications.

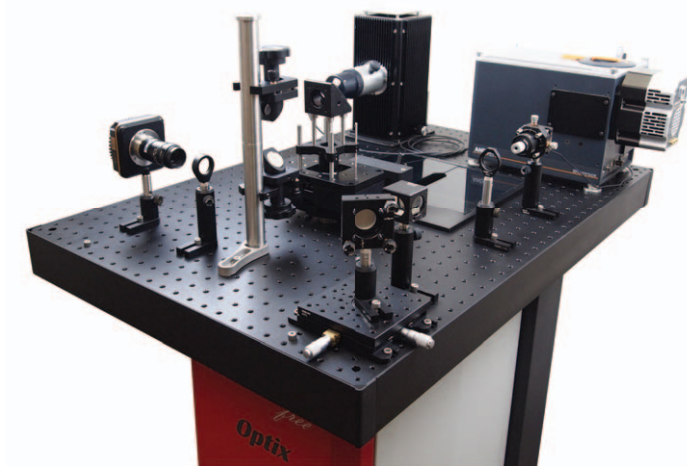

The PPMS® Optix, an optical breadboard attachment, enables further integration of the OMFP with custom optical experiments. Shown here installed on a PPMS VersaLab, the Optix option is available for all members of the PPMS family of instruments.

Optical Multi-Function Probe Specifications

Temperature [T]

Range*: 350 to 5 K (DynaCool, PPMS)
350 to 50 K (VersaLab)

Axial Optical Window

Coupling Type: SM1 (1" diameter)
Included Coatings: 350 to 700 nm, and 650 to 1050 nm

Camera Resolution: < 5 μm^{**}

Piezo-Positioner Stack

Maximum Travel: 3 mm (all axes)
Minimum Step Size***: 1 μm to 1 mm (approx.; user-controlled)
Control Mode***: Open Loop

Operational Range: 0 to 16 T

*Base temperature of 5 K represents the minimum achievable stable temperature under 10 mW of radiant flux.

**Based on resolving individual lines within group 6, element 6 of the 1951 USAF resolution test chart.

***Due to hysteretic effects intrinsic to the piezo-resistive drive elements and open loop operation, precise step sizes may not be repeatable between different temperatures, upon changing drive direction, or at the extreme points of the available range.

Specifications are subject to change without notice.

Raman Spectroscopy System

DynaCool (D760) / PPMS (P760) / VersaLab (V760)

Working in conjunction with the Optical Multi-Function Probe (OMFP), the Raman Spectroscopy Option enables Raman spectra to be collected as a function of temperature and/or magnetic field. The electrical access of the OMFP enables correlative spectroscopic/transport measurements to be made using a single integrated system, all controlled from the MultiVu software interface. The system is suitable for basic structural identification, but also allows for advanced probing of a particular observed mode; the incident beam is linearly polarized and the returning signal automatically separated into two orthogonal polarization channels for subsequent analysis.

Key Features:

- *iVac* spectroscopy camera features Low Dark Current Deep Depletion (LDC-DD) technology for superior noise performance compared to other back-illuminated CCDs
- Other Andor gratings are easily installed for more customized applications; software automatically identifies the new grating using a built-in RFID tag
- Automated internal alignment simplifies signal strength optimization
- Spectrometer, laser source, and OMFP positioners are all controlled through MultiVu and have corresponding sequence commands available for automated data collection

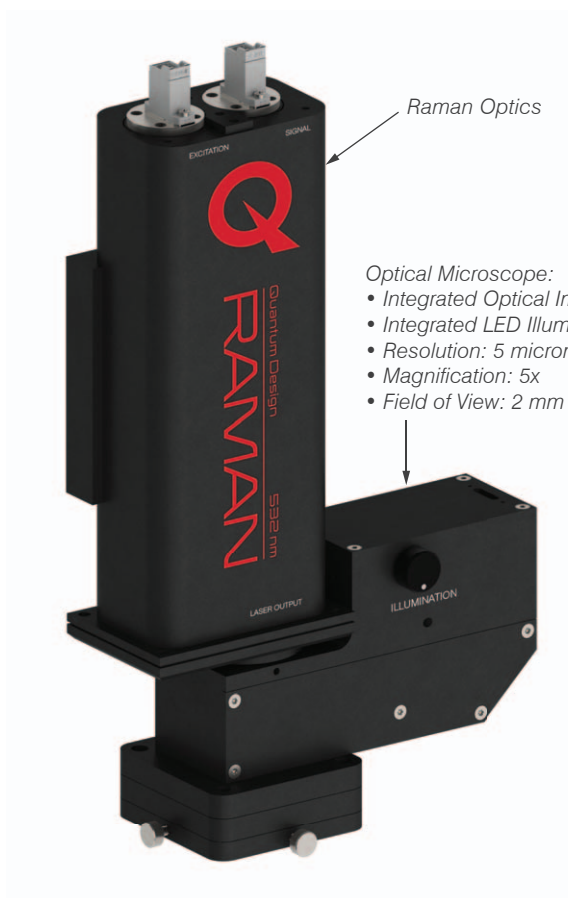

- Optical Microscope:
- Integrated Optical Imager
 - Integrated LED Illuminator
 - Resolution: 5 micrometer or better
 - Magnification: 5x
 - Field of View: 2 mm

The Raman head unit, containing the necessary optical elements for collecting Raman spectra, integrates seamlessly with the OMFP's optical microscope. Both are mounted on a singletip-tilt stage to facilitate proper laser alignment.

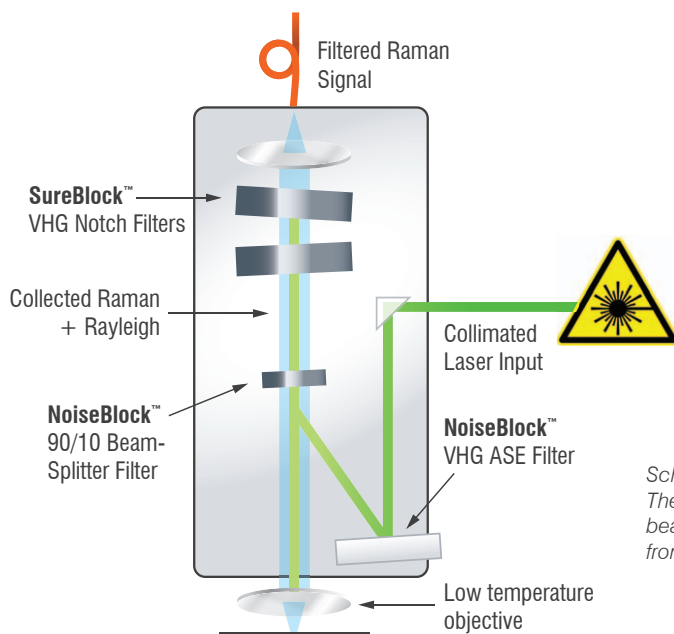

Schematic view of the optical elements comprising the Raman head unit. The filters and splitter are configured to deliver a maximal intensity of excitation beam (shown in green) to the sample while also blocking the same wavelength from entering the spectrometer (to better resolve the Raman signal, shown in blue).

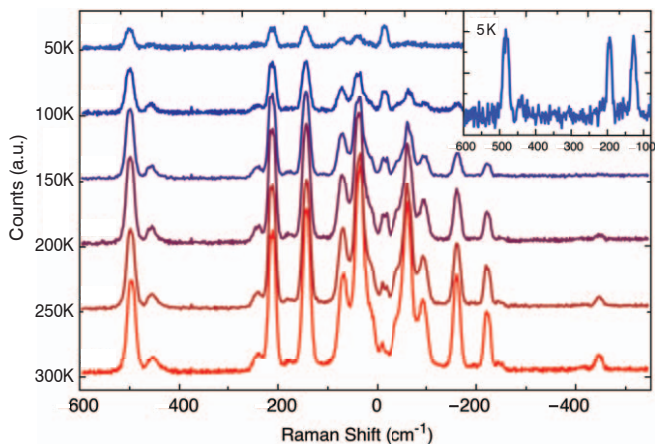

Raman spectra of sulfur using Optical Multi-Function Probe (OMFP) in PPMS and DynaCool. Main plot shows data taken in PPMS at temperatures from 300 to 50 K. Inset shows data taken in DynaCool at base temperature with background removed for clarity.



Andor Kymera 193i spectrograph with included iVac 316 CCD.



The Kymera's dual-grating turret, shown here, can be easily removed and replaced with optional gratings to achieve the required spectral bandwidth or resolution required. Integrated RFID tags allow for easy identification of a grating in the MultiVu software.

Raman Spectroscopy Specifications

Temperature [T]

Range*: 350 to 5 K (DynaCool, PPMS)
350 to 50 K (VersaLab)

Exciting Radiation

Wavelength: 532 nm
Laser Power: 75 mW at sample; typical

Spectrometer

(Andor Kymera 193i)
Focal Length: 193 mm
Aperture: F/3.6
Included Gratings: 300 l/mm and 1200 l/mm; 500 nm blaze, Al + MgF₂ coating
CCD Camera (iVac 316): 2000 × 256 pixels, 15 × 15 μm sq.

Operational Range: 0 to 16 T

*Base temperature of 5 K represents the minimum achievable stable temperature under 10 mW of radiant flux

Specifications are subject to change without notice.

Light Sources

DynaCool (D312, D326) / PPMS (P312, P326) /
VersaLab (V312, V326)

TLS120Xe and MLS Xenon Light Source

Quantum Design provides light sources for sample illumination which are an ideal complement to either the VSM FOSH or Photoconductivity MFP. The MLS Xenon Light Source produces white light which can be filtered down to a specific wavelength using a manually rotated filter wheel, while the TLS120Xe can be tuned automatically with software commands in MultiVu across an even wider range. Both sources output to a standard SMA-style connector and have user-replaceable lamps.

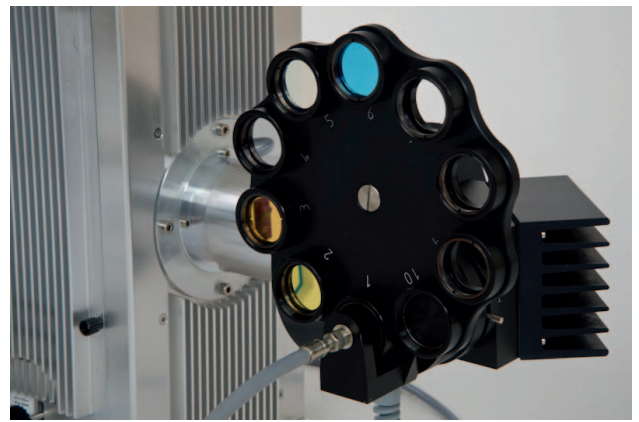

MLS Xenon Light Source shown with the 10-position filter wheel used to produce monochromatic light.



TLS120Xe with manual front panel controls active.

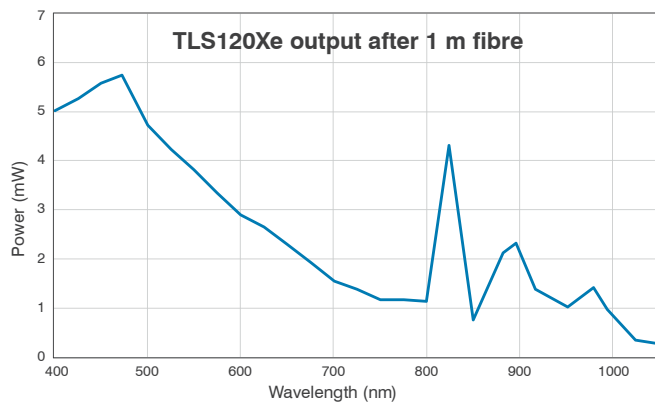

Typical power spectrum of the TLS120Xe denoting approximate radiant flux incident on a sample as a function of wavelength.

Light Sources Specifications

TLS120Xe

Wavelength Range:	280 to 1100 nm
Bandwidth:	20 nm (FWHM)
Grating Line Density:	1200
Nominal Blaze Wavelength:	380 nm
Lamp Type:	Short-arc OFR xenon (100 W)
Lamp Lifetime:	500 hours

MLS Xenon Light Source

Wavelengths (FWHM):	436 nm (20 nm)
	470 nm (40 nm)
	500 nm (20 nm)
	530 nm (30 nm)
	555 nm (20 nm)
	585 nm (40 nm)
	640 nm (30 nm)
	740 nm (40 nm)
	850 nm (40 nm)
Lamp Type:	Short-arc xenon (300 W)

Specifications are subject to change without notice.

Compatibility Table

	DynaCool	PPMS	VersaLab
AC Resistance (ETO)	D605	P605 [Req. Model 1000]	V605
DC Resistance	D400A [Incl. D415]	P400A	V400 [Incl. V415]
Pressure Cell (Transport)	D420 [Req. D605 or D400A]	P420 [Req. P605 or P400A]	V420 [Req. V605 or V400]
Rotator	D310A/B [Incl. D415]	P310A/B	V310A/B [Incl. V415]
VSM	D525	P529 [Incl. Model 1000, Rec. P945]	V525
VSM Large Bore	D529 [Req. D525]	P529 [Req. P525]	V529 [Req. V525]
VSM Oven	D527 [Req. D525]	P527 [Req. P525, P640]	V527 [Req. V525]
FORC Software	D181 [Req. D525]	P181 [Req. P525]	V181 [Req. V525]
FOSH	D320 UV/IR [Req. D525]	P320 UV/IR [Req. P525]	
Pressure Cell (Magnetometry)	D421 [Req. D525]	P421 [Req. P525]	V421 [Req. V525]
Torque Magnetometer	D550 [Req. D310]	P550 [Req. P400A, P310]	V550 [Req. V310]
ACMS II	D505A [Req. D525]	P505A [Req. P525]	V505A [Req. V525]
Thermal Transport	D670	P670 [Req. Model 1000, P640]	V670
Heat Capacity	D650	P650C [Req. Model 1000, P640]	V650
Dilatometer	D680	P680 [Req. Model 1000]	
Adiabatic Demagnetization Refrigerator	D810 [Req. D605 or D400A]	P810 [Req. P640, P605 or P400A]	
Helium-3 Refrigerator	D825A/AV	P825C/CV [Req. Model 1000, P640]	
Dilution Refrigerator	D850A	P850A [Req. Model 1000, P640]	
MFP Types A/M	D450A/M [Req. D415]	P450A/M	V450A/M [Req. V415]
MFP Types B/C	D450B/C	P450B/C	V450B/C
MFP Photoconductivity	D790 [Req. D415, Light Source]	P790 [Req. Light Source]	
MFP CryoFMR	D886A/B	P886A/B	V886A/B
Optical MFP	D725A/B [Req. D415]	P725A/B	V725A/B [Req. V415]

Sub-Kelvin Compatibility Kits

	Range	ETO (D605) / (P605)	Resistivity (D400A) / (P400A)	Heat Capacity (D650) / (P650C)	AC Suscept. for DR (D860) / (P860)
ADR	300 K – 0.1 K	Compatible	Compatible		
³ He	350 K – 0.4 K	Compatible	Compatible	+ D826A/AV / P826A/AV	
DR	4 K – 0.05 K	+ D605-DR / P605-DR	Compatible	+ D856A / P856A	Compatible



Quantum Design
EUROPE

Quantum Design GmbH
Im Tiefen See 58, D-64293 Darmstadt
Tel: +49 6151 88060
www.qd-europe.com
germany@qd-europe.com

Please contact:

Dr. Marc Kunzmann	+49 6151 8806-46	kunzmann@qd-europe.com
David Appel	+49 6151 8806-499	appel@qd-europe.com
Dr. Tobias Adler	+49 6151 8806-479	adler@qd-europe.com